

UPM3

UPM3, UPM3K, UPM3 HYBRID, UPM3 AUTO, UPM3 FLEX AS, UPM3 SOLAR, UPM3 DHW, UPM3S, UPM3L, UPMO

1 x 230 V, 50/60 Hz



1. Introduction	4
UPM3 PWM variants	4
UPM3 HYBRID variants	4
UPM3S variants	4
UPM3L variants	4
UPMO variants	4
Applications	5
Safety instructions	9
2. Features and benefits	10
Features	10
Benefits	10
Features UPM3K	10
Features UPM3S	10
Features UPM3L	10
Features UPMO	10
ErP, Ecodesign regulation in brief	11
Identification	12
3. Performance range	14
4. Product range	16
5. UPM external control mode and signals	18
Control principles	18
6. UPM3 HYBRID control modes, user interface and settings	21
User interface	22
Navigation	23
User interface control modes for UPM3 HYBRID variants	24
7. Technical description	32
Exploded view and sectional view	32
Material specification	32
Description of components	33
8. Installation	42
Pumped liquids	42
Mechanical installation	43
Electrical installation	45
9. Startup	51
10. Service	52
11. Disposing of the product	55
12. Control box positions	56
13. Performance curves and technical data	57
Curve conditions	57
14. Data sheets	58
15. Accessories	100
16. Approvals and certificates	102
EC/EU declaration of conformity	102
VDE certificate	103
EurAsia conformity (EAC) certification	103
Drinking water approvals	103
Grundfos Product Chemical Compliance declaration concerning the non-use of certain chemical substances	103
REACH Regulation (EC 1907/2006)	104
Customer information regarding REACH, RoHS and other relevant chemical legislation and Grundfos' Product Chemical Compliance initiatives	104

WEEE Directive 2012/19/EU	104
17. Abbreviations	105

1. Introduction

UPM3 PWM variants

UPM3(K)	7.5 m	
UPM3(K)	7 m	
UPM3(K)	6 m	Only externally controlled PWM A/C profile or LIN bus/Modbus*
UPM3(K)	5 m	
UPM3(K)	4 m	

* Coming soon

UPM3 HYBRID variants

UPM3(K) FLEX AS	7.5 m	
UPM3(K) FLEX AS	7 m	MAX or externally controlled PWM A profile
UPM3(K) FLEX AS	5 m	
UPM3(K) SOLAR	14.5 m	
UPM3(K) SOLAR	10.5 m	CC or externally controlled PWM C profile
UPM3(K) SOLAR	7.5	
UPM3(K) DHW	7 m	
UPM3(K) DHW	5 m	MAX or externally controlled PWM A profile
UPM3(K) DHW	2 m	
UPM3(K) AUTO	7 m	Only internally controlled PP/CP/CC/AA
UPM3(K) AUTO	5 m	
UPM3(K) HYBRID	7 m	
UPM3(K) HYBRID	5 m	PWM A/C or PP/CP/CC/AA

UPM3S variants

UPM3S	6 m	
UPM3S	5 m	(only externally controlled PWM A/C profile)
UPM3S	4 m	
UPM3S FLEX AS	6 m	(MAX or externally controlled PWM A profile)

* Coming soon

UPM3L variants

UPM3L	7.5 m	(only externally controlled PWM A/C profile)
UPM3L FLEX AS	7.5 m	(MAX or externally controlled PWM A profile)

* Coming soon

UPMO variants

UPMO	6 m	(CC or Radiator or UFH or PWM A profile)
------	-----	--

Note:

PWM A/C: Externally controlled via PWM A or C profile (see page 27)

PWM: Pulse-Width Modulation

PP: Proportional Pressure

CP: Constant Pressure

CC: Constant Curve

MAX: Maximum curve of PWM range

AA: AUTO_{ADAPT}

Radiator: Proportional Pressure AUTO_{ADAPT}

UFH: Constant Pressure AUTO_{ADAPT}

LIN: LIN bus (VDMA 24226)

MOD: Modbus RTU

Applications

In a modern heating, cooling and domestic hot water supply system there are different circuits in which UPM3 pumps in different versions can be placed. A differentiation must be made between the heating (or cooling) production and the distribution.

On the production side there are some applications where pumps are used in primary or internal circuits e.g. for geothermal or solar thermal brine circuits.

The distribution side is often split into two circuits - a primary and a secondary circuit - in order to keep the flow and temperature independent from each other. A heat exchanger, a hydraulic separator or a buffer tank can be used for this separation.

For some heating generators (e.g. condensing boilers, heat pumps or district heating) it is important to keep the return temperature as low as possible. Therefore it is necessary to keep the right balance between flow in primary and secondary circuits. Without separator, the primary pump creates a differential pressure in the secondary circuits. A generator effect can happen in the secondary pump, from which UPM3 is protected.

The primary pump is mostly integrated into the heating appliance and controlled via a digital signal (e.g. PWM) to ensure the optimum operation of the boiler, for instance.

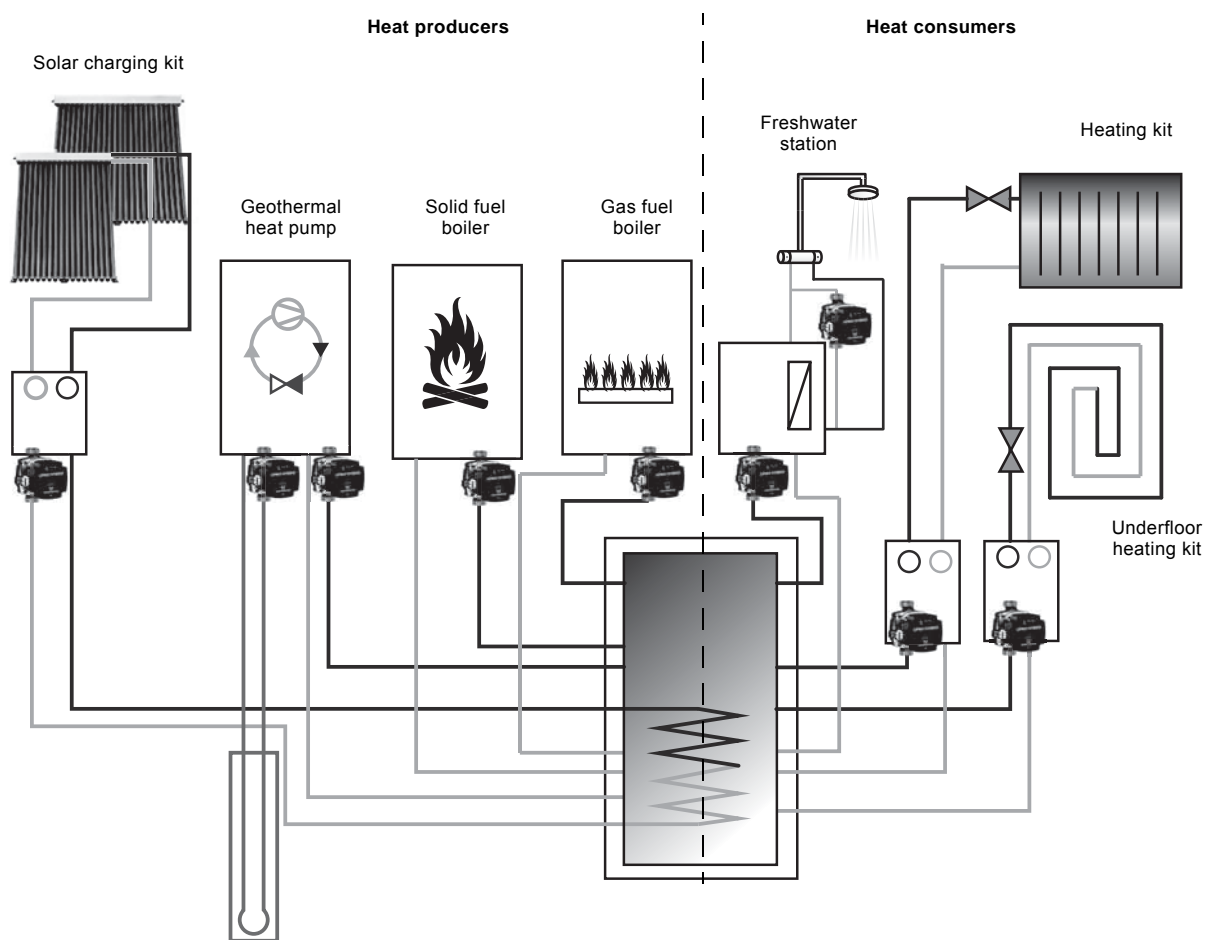

TM07 2331 3118

Fig. 1 Complete domestic heating system combined with renewable energy sources

	Application	Recommended type
Heat production or heat transmission side	Gas or oil-fired space and combination heaters	UPM3, UPM3 FLEX AS, UPM3S, UPM3L
	Solid fuel heaters	UPM3 FLEX AS, UPM3 AUTO, UPM3L
	Heat pumps (brine side)	UPM3 (K), UPM3(K) FLEX AS
	Heat pumps (heating side)	UPM3, UPM3 FLEX AS, UPM3S, UPM3L
	Mini combined heat and power cogeneration	UPM3, UPM3 FLEX AS
	Thermal solar system (collector side)	UPM3(K) SOLAR
	District heating systems with heat exchanger	UPM3 FLEX AS, UPM3 AUTO, UPM3L
Heat distribution side	Space heating systems	UPM3 AUTO, UPM3 HYBRID
	Space heating and cooling systems	UPM3(K) AUTO, UPM3(K) HYBRID
	Domestic hot water generation (heating side)	UPM3 FLEX AS
	Domestic hot water generation (DHW side)	UPM3(K) DHW
	Domestic hot water recirculation	UPM3 DHW

Gas or oil-fired space and combination heaters

Most of the installed systems for space and water heating in building services are still using fossil fuels such as natural gas or mineral oil, although the use of gas and liquid fuels out of biomass is increasing. Heaters with higher water content, such as floor-standing boilers, are heated independent of the actual flow. Heaters as wall-mounted boilers are only fired when there is a minimum flow through the primary heat exchanger. In a combi-boiler, the pump supplies both the heating system and the hot water supply.

More and more of these heaters are condensing boilers temperature-controlled by a weather-compensating system controller with different time programs, which means the central heating water temperature is often lower than the domestic hot water temperature. In systems with domestic hot water supply either as combination heaters with integrated DHW supply or with external DHW tank or heat exchanger there is a need to increase the medium temperature temporarily above DHW temperature level. In small residential buildings, the heating demand for DHW is higher than for space heating.

Internal (or external) pumps for these primary circuits must be controlled by the needs of the heaters to optimise the combustion conditions and the condensation process. Often this can only be guaranteed by using a variable-speed pump with external control signal from the boiler controller.

Solid fuel heaters

As most of these heaters use wood biomass such as pellets, split logs or wood chips, they can be seen as renewable energy and CO₂ neutral. These heaters are mostly reacting slowly on different heat demands. For this reason, the liquid temperature might increase and there is a need for keeping the flow constant and for storing the energy in a buffer tank.

Heat pumps

Different types of heat pumps are on the market:

- Compressor heat pumps with electric or combustion motors
- Sorption heat pumps. Sorption is a physical-chemical process where either a liquid or a gas is absorbed by another liquid (absorption) or is retained by the surface of a solid object (adsorption). Both processes are reversible and only occur under certain conditions through physical effects (pressure, temperature). Often a pump with customised specification is installed inside such a process unit.

Primary pumps are depending on the heat transmission principle:

- Air-to-air heat pumps are often used in air-conditioning systems
 - No pump is used.
- Air-to-water heat pumps for space heating and cooling or water heating
 - The heat source is mainly outdoor air down to an outside temperature of minus 20 °C. Its energy is mainly extracted directly by a fan-supplied air evaporator of the heat pump. Sometimes there is a primary brine circuit between an outdoor air unit and a brine-to-water heat pump. This circuit is circulated by a pump that must stand liquid temperatures down to minus 20 °C.
- Water-to-water heat pumps for space heating and cooling or water heating
 - The energy source can be groundwater between 7 and 12 °C. Groundwater is extracted mainly via a submersible pump in a supply well and returned via a return well. If its water quality is not guaranteed, there is a primary circuit between a heat exchanger and the heat pump. This circuit is circulated by a pump that must stand liquid temperatures down to plus 2 °C.
- Brine-to-water heat pumps for space heating and cooling or water heating
 - Horizontal ground collectors or probes set vertically into the ground deliver the ground-stored solar energy via a mixture of water and antifreeze (brine) to the evaporator of the heat pump. This circuit is circulated by a pump that must stand liquid temperatures down to plus 2 °C or lower. For smaller heat pumps with a minimum brine temperature of +2 °C, we recommend UPM3K with PWM signal input.

The secondary pumps do not differ much from boiler applications. The liquid temperature is normally not above 60 °C, the differential temperature is mostly small, e.g. ΔT 5K. Constant-speed compressor heat pumps often require constant flow and long cycle times. A buffer tank can prolong the cycle time and make the flow through the heat pump independent of the flow in the heating distribution circle. Variable-speed compressors often go together with a variable-speed pump, which should be externally controlled by the heat pump controller.

Micro/Mini combined heat and power cogeneration

Cogeneration of heat and power (CHP) can be divided into combustion engines, stirling engines and fuel cells. Dosing and pumps with customised specification are often installed inside the fuel cell process unit. Used secondary pumps are not that different from boiler applications. However, vibrations, liquid temperature and ambient temperature can be relatively high. Often a constant flow is required, therefore a buffer tank is an advantage.

Thermal solar system

Solar collectors convert sunlight into heat that can be used for heating or domestic hot water supply of buildings. The primary circuit is only in use, if there is a positive temperature difference between the collector and the heat exchanger or tank. In pressurised thermal solar systems, pumps must stand glycol-based solar liquids with a high temperature range from +2 °C up to 110 °C with short peaks of up to 130 °C. Rarely, during startup of the system, the liquid temperature can cause condensation in the pump. For this reason, the UPM3 SOLAR has a drain hole, which must point downwards. The required flow and head can vary depending on the sizing of the system components. In a drain-back system the pump must be able to fill up the system each time it starts, which means that the head must be as high as the geodetic height of the system top.

UPM3 SOLAR is designed to be integrated in all kinds of thermal solar systems with either variable (matched-flow) or constant flow. High-efficiency ECM pumps such as UPM3 must not be speed-controlled by an external speed controller varying or pulsing the supply voltage. The speed can be controlled by a low-voltage PWM C signal from a solar controller in order to optimise the solar harvesting and the temperature of the system. Additionally, the power consumption of the pump will be reduced considerably. If no PWM signal is available, UPM3 SOLAR can be set to constant speed, only switched on and off by the controller.

District heating systems with heat exchanger

District heating systems supply all kinds of buildings with space heating and domestic hot water centrally or by flat stations. In systems with heat exchangers, the secondary pumps do not differ much from boiler applications, because system pressure and temperature are equal.

Space heating systems

The secondary pump is often a self-controlled stand-alone pump, which can be mounted in a heating kit, and responds to the changing flow demand of heat consumers like radiators or underfloor heating circuits. Providing the best operating conditions for all components, hydraulic balancing is important for well-performing hydraulic systems. Especially in two-pipe heating systems with thermostatic valves, hydraulic balancing helps to avoid noises, oversupply, undersupply, too high pump performance, and saves energy. If an automatic bypass valve is installed to ensure a minimum flow, you must adjust the differential pressure control of the pump in a way to ensure the function of the automatic bypass valve. For example, select a constant pressure curve that is higher than the differential pressure of the valve. The maximum liquid temperature and differential temperature depends on the system design. T_{\max} is normally from 30 to 90 °C, ΔT is between 5 and 20 K.

Combined space heating and cooling systems

Floor-heating or ceiling-cooling systems together with reversible heat pumps can heat rooms in winter and reduce the temperature of the room air by an appreciable 4 to 6 degrees in summer with one system. When cooling the system, the liquid temperature must be kept above the dew point of the air to avoid condensing on the cooled floor, walls or ceilings. Condensation can occur in the pump occasionally. For this reason, it is recommended to use UPM3K pumps in such systems.

Domestic hot water generation

In indirect heated DHW systems, the pump can be placed on both sides of the heat exchanger. In a DHW cylinder, potable water is stored and usually heated indirectly by primary heating water from the boiler either by an external plate heat exchanger or by an internal indirect coil. Especially in renewable energy sourced systems, the primary heating water is stored and instant hot water is created by fresh water stations.

Domestic hot water recirculation

Hot water recirculation pumps circulate the potable water on the secondary side from the taps back to the water heater to ensure comfort and to avoid legionella. All pumps that come into contact with drinking water must be approved to be suitable for drinking water. UPM3 DHW are offered with either stainless steel or PPS housings, which are approved by KTW (DE), DVGW W270 (DE), ACS (FR) and WRAS (GB).

UPM3 - PWM variants

This pump range is designed for integration in boilers and other heating appliances with remote control of the speed, corresponding to low-voltage PWM signal input.

UPM3 - HYBRID variants

This pump range with user interface is designed for several purposes:

- The internal-controlled variant can be used in heating appliances as stand-alone or replacement pump, for example in heating kits.
- The remote-controlled variant can be integrated in boilers and other heating appliances where the speed is changed, corresponding to low-voltage PWM signal input.
- A combination of both.

The internal-controlled variants are suitable for the following systems:

- Systems with constant or slightly variable flows such as one-pipe heating systems
- Systems with variable flows such as two-pipe heating systems with thermostatic valves for radiators or underfloor heating.

Examples of systems

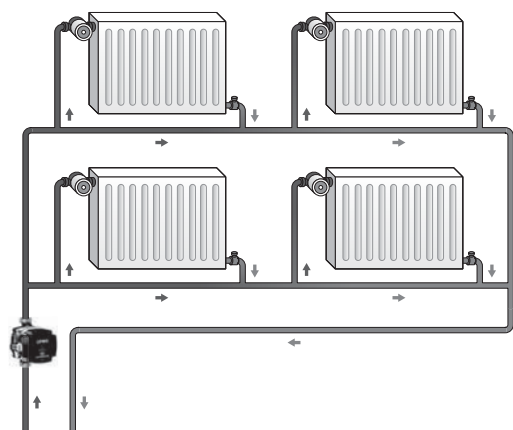

Fig. 2 One-pipe heating system

TM06 0528 0414

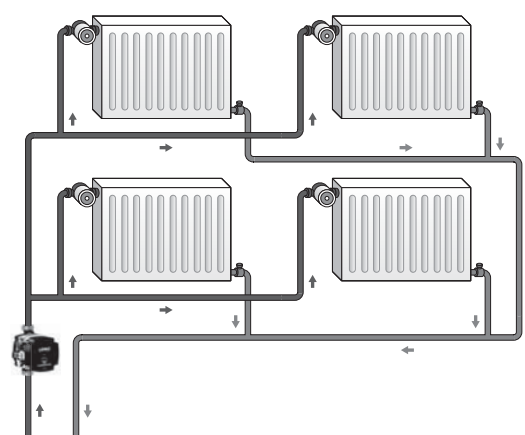

Fig. 3 Two-pipe heating system

TM06 0526 0414

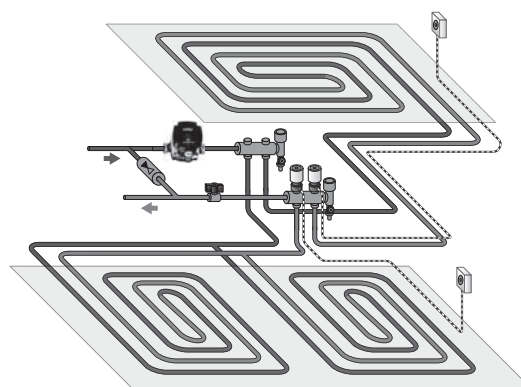

Fig. 4 Underfloor heating system

TM06 0526 0414

Safety instructions



Read this document before installing the product. Installation and operation must comply with local regulations and accepted codes of good practice.

General information

Target group

Qualification and training

The persons responsible for installation, startup, operation and maintenance must be appropriately qualified for these tasks. Areas of responsibility, levels of authority and the supervision of the persons must be precisely defined by the operating company. If necessary, the persons must be trained.

Symbols used in this document



DANGER

Indicates a hazardous situation which, if not avoided, will result in death or serious personal injury.



WARNING

Indicates a hazardous situation which, if not avoided, could result in death or serious personal injury.



CAUTION

Indicates a hazardous situation which, if not avoided, could result in minor or moderate personal injury.



A blue or grey circle with a white graphical symbol indicates that an action must be taken.



If these instructions are not observed, it may result in malfunction or damage to the equipment.



Tips and advice that make the work easier.

Storage and transport

- Observe the permissible ambient conditions.
- The storage location must be protected from rain, humidity, condensation, direct sunlight and dust.
- Maximum storage time (without power supply): 2 years from delivery.
- Use appropriate lifting and transporting devices.
- Observe the maximum stacking height of pallets.

Non-observance of the safety instructions may have dangerous consequences for persons, the environment and the product.

2. Features and benefits

Features

- Speed-controlled, high-efficiency pump fitted with electronically commutated motor (ECM) with permanent-magnet rotor and frequency converter.
- Either externally controlled by digital pulse-width modulation (PWM) low-voltage signal or internally controlled in Constant Pressure, Proportional Pressure or Constant Speed mode defined by the means of a smart user interface or factory pre-setting.
- Third generation of the first boiler-integrated, variable-speed ECM pumps which combines both validated and newly developed components and concepts.
- Highly reliable as more than 5,000,000 UPM units have been installed with success since 2006.
- Fit into existing boiler ranges, small as UP15 standard pumps.
- Cost-optimised and reliably available due to new established mass production facilities.
- Energy-optimised due to improved hydraulic and motor efficiency.

Benefits

- Use up to 87 % less electrical power than conventional constant-speed pumps.
- Use up to 68 % less electrical power than conventional speed-controlled pumps.
- Use up to 25 % less electrical power than the first generation of ECM pumps.

Unique Selling Points of UPM3 and UPM3 HYBRID variants

- UPM3 is the first Grundfos high efficiency pump with terminal box in front and access to a mechanical deblocking device.
- UPM3 is the first Grundfos high efficiency pump for high ambient and media temperature of up to 70 °C / 110 °C.
- UPM3 is the first Grundfos high efficiency pump with SSI for active inrush current limitation below 5 Ampere.
- UPM3 is the first Grundfos high efficiency, PWM controlled pump with an EEI below benchmark level of $EEI \leq 0.20$.
- UPM3 is the first Grundfos OEM pump with TE Superseal connectors for power and signal supply.
- UPM3 AUTO is the first Grundfos self-controlled pump with $AUTO_{ADAPT}$ Constant Pressure mode, which can be used in underfloor heating systems.
- UPM3 HYBRID is the first hybrid version of externally and internally controlled, high efficiency Grundfos pumps.
- UPM3 LIN is the first Grundfos LIN bus pump for appliance-integrated communication.

Features UPM3K

- The UPM3K pump range is designed for condensing applications with media below ambient temperature.
- The stator housing is CED electrocoated with one drain hole in two possible positions, as IPX4D.
- The minimum admissible media temperature can be down to -10 °C.

Features UPM3S

- The UPM3S pump range is designed for integration in boilers and other heating appliances with limited performance up to 6 m / 42 W.
- Its rotor is injection-moulded with PPS bonded hard ferrite magnetic particles.

Features UPM3L

- The UPM3L pump range is designed for integration in boilers and other heating appliances with extended performance up to 7.5 m / 75 W.
- The ambient temperature is limited to 55 °C.
- The media temperature is limited to 95 °C (TF95).

Features UPMO

- UPMO pumps are designed for replacement in systems that use old hydraulic interfaces with UP/ UPO, UPS/UPSO, UPR/UPRO, UPER/UPERO pump heads.
- The UPMO pump head fits most of the existing small UP15 housings that are used in IWC or hydro blocks, as well as customised or standard housings made of composite, cast iron, bronze or stainless steel.
- UPMO can be used as ErP conform replacement for asynchronous integrated or stand-alone pumps in existing heating systems.
- UPMO can be used with internal control mode constant pressure, UFH (constant pressure $AUTO_{ADAPT}$) or radiator (proportional pressure $AUTO_{ADAPT}$) on defined pump housings.
- UPMO is equipped also with PWM interface using PWM profile A.
- The performance of UPMO pumps might be different from the performance of the pumps that should be replaced. The power consumption is significantly lower, the PWM signal is not compatible. Grundfos HVAC OEM together with the OEM customer have to check in a validation process, if successful replacement is possible.
- UPMO is fulfilling all CE requirements, such as LVD, EMC & ErP. Inrush current is limited by SSI. Space and temperature features suit most OEM requirements. Therefore it can be used in most heating appliances without constraints.

ErP, Ecodesign regulation in brief

The EU has addressed the climate challenge in a EuP/ErP directive: Since August 2015, all stand-alone pumps as well as pumps integrated in boiler systems, solar systems and heat pump systems must fulfil Ecodesign requirements, defined in regulation 641/2009/EC on glandless pumps, which was amended by 622/2012/EC. The regulation has set radically new standards for energy efficiency.

The essentials

- Glandless pumps integrated in products must have an energy efficiency index (EEI) of not more than 0.23. The benchmark level is 0.20.
- Stand-alone pumps are measured according to EN 16297-2.
- Integrated pumps are measured according to EN 16297-3, due to their various functions integrated in many customised hydraulic solutions on the market.
- All pumps integrated in products which generate and/or transfer heat and all types of media are included. This means that not only heating systems, but also solar thermal and heat pump systems are affected by the Ecodesign regulation.
- Non-compliant spare pumps for integrated pumps sold before August 2015 are allowed until January 1st, 2020.
- Pumps designed for recirculation of drinking water are out of scope of this regulation.
- Conformity with EU regulations are governed through mandatory CE marking.

All UPM3(K), UPM3S, UPM3L, UPMO variants meet the Ecodesign requirements measured by EN 16297-2 and EN 16297-3:2012.

Identification

Type key

Example: UPM3 SOLAR 15 -145 130 C A EU X 9 XXX

Type

UPM3	Standard
UPM3K	Cold water version
UPM3S	Small version with IMM rotor
UPM3L	Large version with extended P1
UPMO	For ErP upgrade and replacement

Control variant

FLEX AS	PWM A, MAX
SOLAR	PWM C, CC
DHW	PWM A, MAX
AUTO	PP, CP, CC, AA
HYBRID	PWM A/C, PP, CP, CC, AA
LIN	LIN bus
MOD	Modbus

Nominal diameter

15	R 1/2" / G 1"
25	R 1" / G 1 1/2"
32	R 1 1/4" / G 2"

Maximum head

20	2 m
40	4 m
50	5 m
60	6 m
70	7 m
75	7.5 m
105	10.5 m
145	14.5 m

Pump housing

130	Cast iron CED, 130 mm
180	Cast iron CED, 180 mm
N 130	Stainless steel, 130 mm
N 150	Stainless steel, 150 mm
N 180	Stainless steel, 180 mm
GGES2	Cast iron CED, end suction UPM3
GGAOS3	Cast iron CED, AOS3 UPM3
GGMBP3	Cast iron CED, GGMBP3 UPM3
GGBP3	Cast iron CED, GGBP3 UPM3
CIL3PA	Composite CIL3, PA6.6 UPM3
CIL3PP	Composite CIL3, PPS UPM3
CIAO2A	Composite CIAO2 AC
CIAO2	Composite CIAO2
CESAO1	Composite CESAO1
CESAO2	Composite CESAO2
CESAO4	Composite CESAO4
CACAO	Composite CACAO
AOKR	Composite AOKR
CAOD3	Composite CAOD3 UPM3

Customer code

XXX

Control box orientation

3	3 h (right)
6	6 h (below)
9	9 h (left)
0	12 h (top)

Control signal connector

X	TE MSS NdFeB	Relay
Y	FCI NdFeB	Relay
V	TE MSS NdFeB	NTC
W	FCI NdFeB	NTC
N	TE MSS NdFeB	SSI
O	FCI NdFeB	SSI
T	TE MSS IMM	NTC
U	FCI IMM	NTC
P	TE MSS IMM	SSI
Q	FCI IMM	SSI

Voltage

EU 230 VAC

Minimum speed

A	0-563 rpm
J	> 2.025 rpm

External control signals 1 and 2

A	PWM A profile, heating
C	PWM C profile, solar
N	LIN bus
Z	No profile

Nameplate options

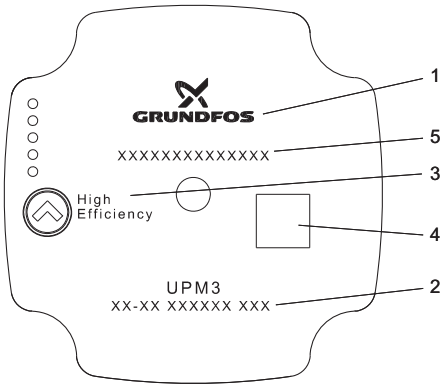

Fig. 5 Nameplate: Grundfos standard

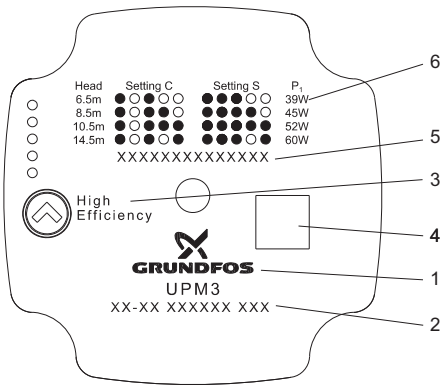

Fig. 6 Nameplate: Grundfos with setting indication

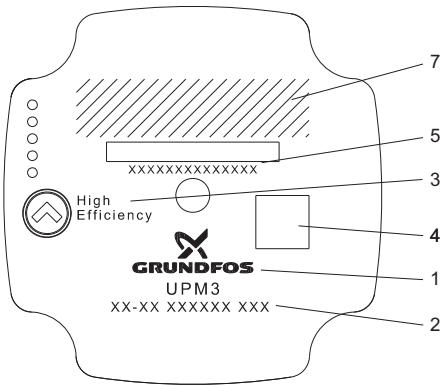

Fig. 7 Nameplate: customised layout

Pos.	Description
1	Grundfos logo
2	Grundfos pump type
3	High efficiency indicating ECM technology
4	Grundfos data matrix
5	Customer product number or barcode
6	Settings indication
7	Area for customer specific logo

Terminal box side

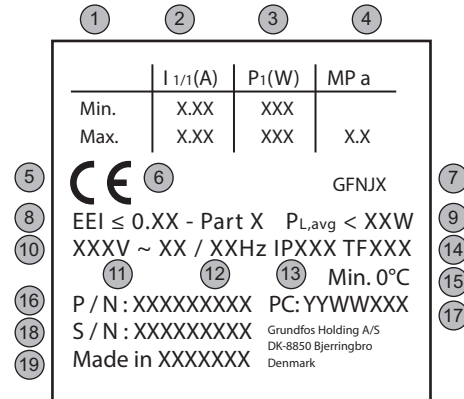

Fig. 8 Terminal box side

Pos.	Terminal box side
1	Speed
2	Rated current, I _{1/1} [A] at maximum and minimum
3	Input power P ₁ [W] at maximum and minimum
4	Maximum system pressure [MPa]
5	CE mark
6	Approvals
7	Product mark (referring to the Declaration of Conformity and other approvals)
8	Energy index with indication of measurement standard
9	Average power input P _{L,avg} (Ecodesign regulation)
10	Power supply voltage AC
11	Voltage [V]
12	Frequency [Hz]
13	Enclosure class
14	Temperature class
15	Minimum medium temperature (only cold water pumps)
16	Product number PN
17	Production code PC (YYWWCustomerID)
18	Serial number SN
19	Place of production

TM06 4421 2215

TM06 4420 2215

TM06 4419 2215

TM06 8435 0517

3. Performance range

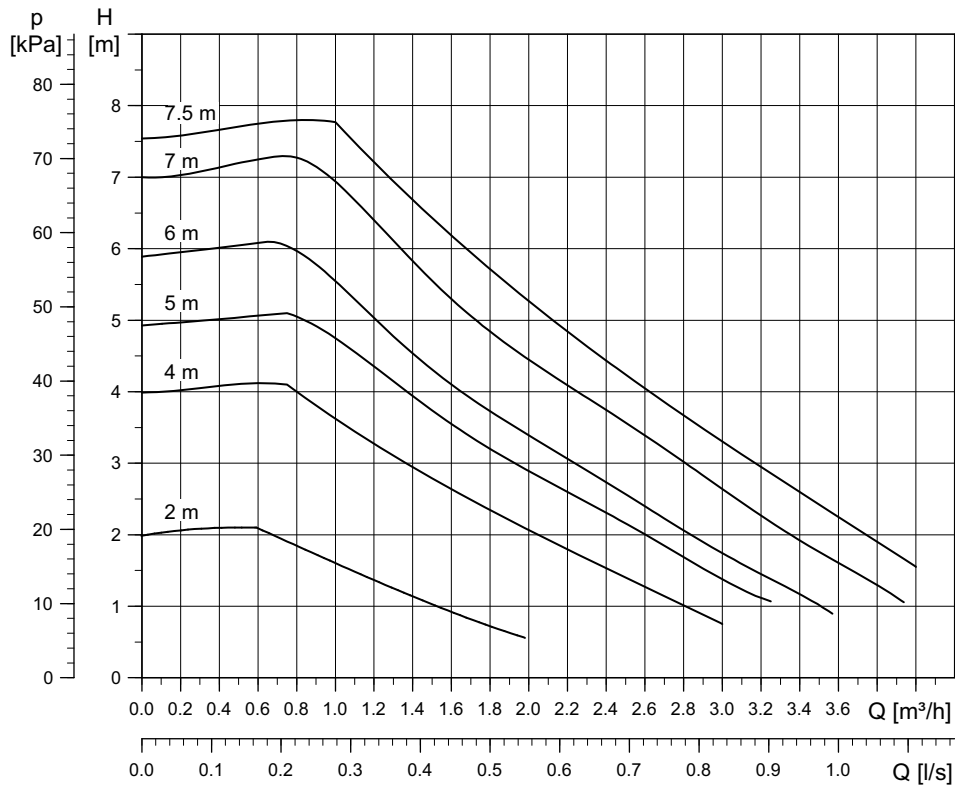

Fig. 9 Performance range UPM3, cast iron pump housing

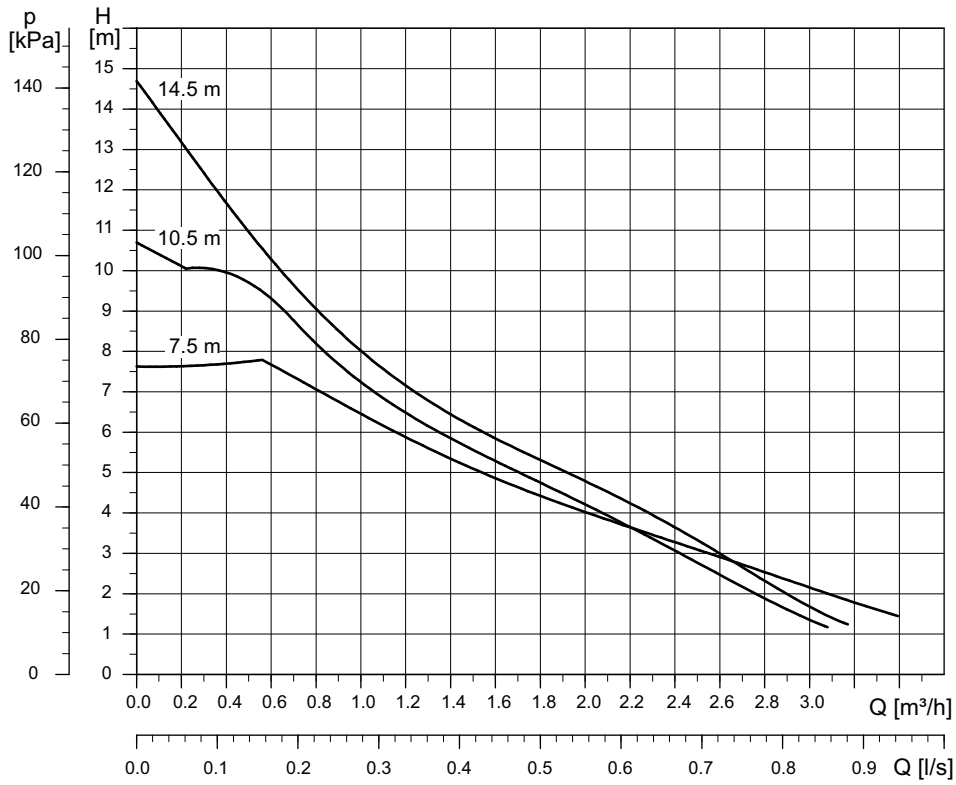

Fig. 10 Performance range UPM3 SOLAR, cast iron pump housing

TM06 8462 0617

TM06 8463 0617

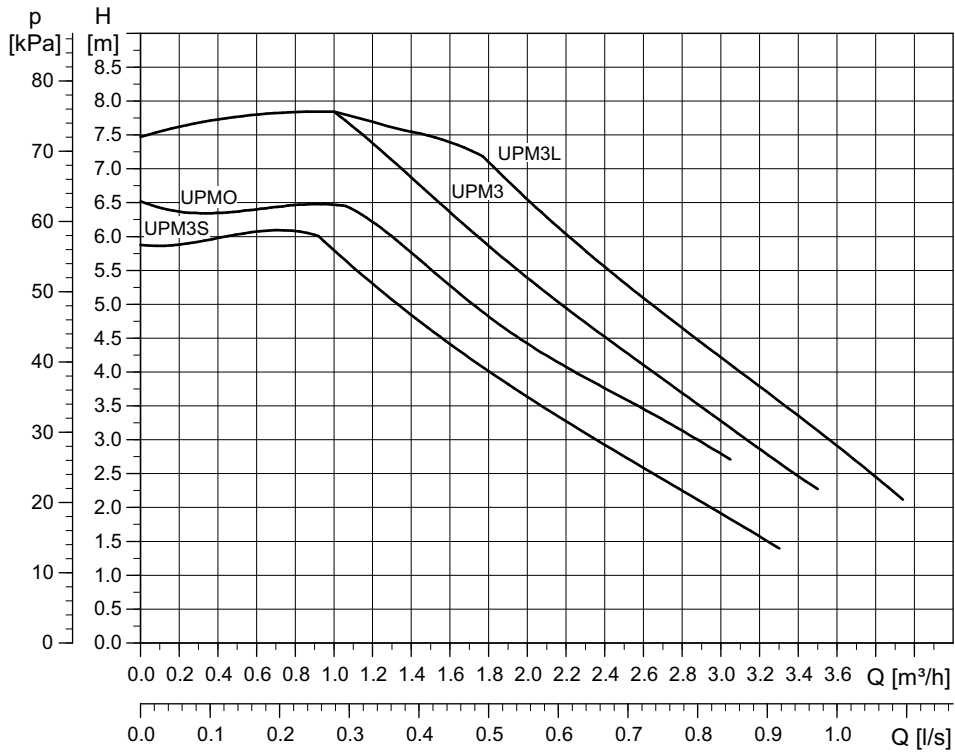

Fig. 11 Performance range UPM3, UPM3L, UPM3S, UPMO

TM07 2400 3418

4. Product range

Pump type	Port-to-port length [mm]	Connection pipe thread ["]	Control signal		Voltage + 10/- 15 % 50 Hz
			Internally controlled PP/CP/CC	Digital low voltage PWM bidirectional	
UPM3(K)					
UPM3(K) 15-75 130 (N)	130	R 1/2 / G 1	-	•	1 x 230 V
UPM3(K) 25-75 130 (N)	130	R 1 / G 1 1/2	-	•	1 x 230 V
UPM3(K) 25-75 180 (N)	180	R 1 / G 1 1/2	-	•	1 x 230 V
UPM3(K) 32-75 180 (N)	180	R 1 1/4 / G 2	-	•	1 x 230 V
UPM3(K) 15-70 130 (N)	130	R 1/2 / G 1	-	•	1 x 230 V
UPM3(K) 25-70 130 (N)	130	R 1 / G 1 1/2	-	•	1 x 230 V
UPM3(K) 25-70 180 (N)	180	R 1 / G 1 1/2	-	•	1 x 230 V
UPM3(K) 32-70 180 (N)	180	R 1 1/4 / G 2	-	•	1 x 230 V
UPM3(K) 15-60 130 (N)	130	R 1/2 / G 1	-	•	1 x 230 V
UPM3(K) 25-60 130 (N)	130	R 1 / G 1 1/2	-	•	1 x 230 V
UPM3(K) 25-60 180 (N)	180	R 1 / G 1 1/2	-	•	1 x 230 V
UPM3(K) 32-60 180 (N)	180	R 1 1/4 / G 2	-	•	1 x 230 V
UPM3(K) 15-50 130 (N)	130	R 1/2 / G 1	-	•	1 x 230 V
UPM3(K) 25-50 130 (N)	130	R 1 / G 1 1/2	-	•	1 x 230 V
UPM3(K) 25-50 180 (N)	180	R 1 / G 1 1/2	-	•	1 x 230 V
UPM3(K) 32-50 180 (N)	180	R 1 1/4 / G 2	-	•	1 x 230 V
UPM3(K) 15-40 130 (N)	130	R 1/2 / G 1	-	•	1 x 230 V
UPM3(K) 25-40 130 (N)	130	R 1 / G 1 1/2	-	•	1 x 230 V
UPM3(K) 25-40 180 (N)	180	R 1 / G 1 1/2	-	•	1 x 230 V
UPM3(K) 32-40 180 (N)	180	R 1 1/4 / G 2	-	•	1 x 230 V
UPM3(K) FLEX AS 15-75 130 (N)	130	R 1/2 / G 1	-	•	1 x 230 V
UPM3(K) FLEX AS 25-75 130 (N)	130	R 1 / G 1 1/2	-	•	1 x 230 V
UPM3(K) FLEX AS 25-75 180 (N)	180	R 1 / G 1 1/2	-	•	1 x 230 V
UPM3(K) FLEX AS 32-75 180 (N)	180	R 1 1/4 / G 2	-	•	1 x 230 V
UPM3(K) FLEX AS 15-70 130 (N)	130	R 1/2 / G 1	-	•	1 x 230 V
UPM3(K) FLEX AS 25-70 130 (N)	130	R 1 / G 1 1/2	-	•	1 x 230 V
UPM3(K) FLEX AS 25-70 180 (N)	180	R 1 / G 1 1/2	-	•	1 x 230 V
UPM3(K) FLEX AS 32-70 180 (N)	180	R 1 1/4 / G 2	-	•	1 x 230 V
UPM3(K) FLEX AS 15-50 130 (N)	130	R 1/2 / G 1	-	•	1 x 230 V
UPM3(K) FLEX AS 25-50 130 (N)	130	R 1 / G 1 1/2	-	•	1 x 230 V
UPM3(K) FLEX AS 25-50 180 (N)	180	R 1 / G 1 1/2	-	•	1 x 230 V
UPM3(K) FLEX AS 32-50 180 (N)	180	R 1 1/4 / G 2	-	•	1 x 230 V
UPM3(K) AUTO 15-70 130 (N)	130	R 1/2 / G 1	•	-	1 x 230 V
UPM3(K) AUTO 25-70 130 (N)	130	R 1 / G 1 1/2	•	-	1 x 230 V
UPM3(K) AUTO 25-70 180 (N)	180	R 1 / G 1 1/2	•	-	1 x 230 V
UPM3(K) AUTO 32-70 180 (N)	180	R 1 1/4 / G 2	•	-	1 x 230 V
UPM3(K) AUTO 15-50 130 (N)	130	R 1/2 / G 1	•	-	1 x 230 V
UPM3(K) AUTO 25-50 130 (N)	130	R 1 / G 1 1/2	•	-	1 x 230 V
UPM3(K) AUTO 25-50 180 (N)	180	R 1 / G 1 1/2	•	-	1 x 230 V
UPM3(K) AUTO 32-50 180 (N)	180	R 1 1/4 / G 2	•	-	1 x 230 V
UPM3(K) HYBRID 15-70 130 (N)	130	R 1/2 / G 1	•	•	1 x 230 V
UPM3(K) HYBRID 25-70 130 (N)	130	R 1 / G 1 1/2	•	•	1 x 230 V
UPM3(K) HYBRID 25-70 180 (N)	180	R 1 / G 1 1/2	•	•	1 x 230 V
UPM3(K) HYBRID 32-70 180 (N)	180	R 1 1/4 / G 2	•	•	1 x 230 V
UPM3(K) HYBRID 15-50 130 (N)	130	R 1/2 / G 1	•	•	1 x 230 V
UPM3(K) HYBRID 25-50 130 (N)	130	R 1 / G 1 1/2	•	•	1 x 230 V
UPM3(K) HYBRID 25-50 180 (N)	180	R 1 / G 1 1/2	•	•	1 x 230 V
UPM3(K) HYBRID 32-50 180 (N)	180	R 1 1/4 / G 2	•	•	1 x 230 V
UPM3(K) DHW 25-70 130 N	130	R 1 / G 1 1/2	•	-	1 x 230 V
UPM3(K) DHW 25-70 180 N	180	R 1 / G 1 1/2	•	-	1 x 230 V
UPM3(K) DHW 32-70 180 N	180	R 1 1/4 / G 2	•	-	1 x 230 V
UPM3(K) DHW 25-50 130 N	130	R 1 / G 1 1/2	•	-	1 x 230 V
UPM3(K) DHW 25-50 180 N	180	R 1 / G 1 1/2	•	-	1 x 230 V
UPM3(K) DHW 32-50 180 N	180	R 1 1/4 / G 2	•	-	1 x 230 V
UPM3(K) DHW 25-20 130 N	130	R 1 / G 1 1/2	•	-	1 x 230 V
UPM3(K) DHW 25-20 180 N	180	R 1 / G 1 1/2	•	-	1 x 230 V
UPM3(K) DHW 32-20 180 N	180	R 1 1/4 / G 2	•	-	1 x 230 V
UPM3(K) DHW 15-70 CIL3 PPS	130	R 1/2 / G 1	•	-	1 x 230 V
UPM3(K) DHW 15-50 CIL3 PPS	130	R 1/2 / G 1	•	-	1 x 230 V
UPM3(K) DHW 15-20 CIL3 PPS	130	R 1/2 / G 1	•	-	1 x 230 V
UPM3(K) SOLAR 15-145 130	130	R 1/2 / G 1	•	-	1 x 230 V
UPM3(K) SOLAR 25-145 130	130	R 1 / G 1 1/2	•	-	1 x 230 V
UPM3(K) SOLAR 25-145 180	180	R 1 / G 1 1/2	•	-	1 x 230 V

Pump type	Port-to-port length [mm]	Connection pipe thread ["]	Control signal		Voltage + 10/- 15 % 50 Hz
			Internally controlled PP/CP/CC	Digital low voltage PWM bidirectional	
UPM3(K)					
UPM3(K) SOLAR 15-105 130	130	R 1/2 / G 1	•	-	1 x 230 V
UPM3(K) SOLAR 25-105 130	130	R 1 / G 1 1/2	•	-	1 x 230 V
UPM3(K) SOLAR 25-105 180	180	R 1 / G 1 1/2	•	-	1 x 230 V
UPM3(K) SOLAR 15-75 130	130	R 1/2 / G 1	•	-	1 x 230 V
UPM3(K) SOLAR 25-75 130 (N)	130	R 1 / G 1 1/2	•	-	1 x 230 V
UPM3(K) SOLAR 25-75 180 (N)	180	R 1 / G 1 1/2	•	-	1 x 230 V
UPM3(K) SOLAR 32-75 180 (N)	180	R 1 1/4 / G 2	•	-	1 x 230 V
UPM3(K) FLEX AS 15-75 CIL3 PPS	130	R 1/2 / G 1	•	-	1 x 230 V
UPM3(K) FLEX AS 15-75 CIL3 PA	130	R 1/2 / G 1	•	-	1 x 230 V
UPM3(K) FLEX AS 15-75 GGES3	ES	R 1/2 / G 1	•	-	1 x 230 V
UPM3(K) FLEX AS 15-75 GGMBP3	BP	See data sheet page 81	•	-	1 x 230 V
UPM3(K) FLEX AS 15-75 GGBP3	BP	See data sheet page 82	•	-	1 x 230 V
UPM3(K) FLEX AS 15-75 CIAO2	130	R 1/2 / G 1	•	-	1 x 230 V
UPM3(K) FLEX AS 15-75 CIAO2 AC	130	R 1/2 / G 1	•	-	1 x 230 V
UPM3(K) FLEX AS 15-75 CES3	ES	R 1/2 / G 1	•	-	1 x 230 V
UPM3(K) FLEX AS 15-75 CACAO	130	R 1/2 / G 1	•	-	1 x 230 V
UPM3(K) FLEX AS 15-75 CESAO1	OEM	See data sheet page 88	•	-	1 x 230 V
UPM3(K) FLEX AS 15-75 CESAO2	OEM	See data sheet page 89	•	-	1 x 230 V
UPM3(K) FLEX AS 15-75 CESAO4	OEM	See data sheet page 90	•	-	1 x 230 V
UPM3(K) FLEX AS 15-75 AOKR	OEM	See data sheet page 91	•	-	1 x 230 V
UPM3(K) FLEX AS 15-75 CAOD	OEM	See data sheet page 92	•	-	1 x 230 V
UPM3(K) FLEX AS 15-75 GGAOS3	OEM	See data sheet page 83	•	-	1 x 230 V
UPM3S					
UPM3S 15-60 130	130	R 1/2 / G 1	-	•	1 x 230 V
UPM3S 15-50 130	130	R 1/2 / G 1	-	•	1 x 230 V
UPM3S 15-40 130	130	R 1/2 / G 1	-	•	1 x 230 V
UPM3S FLEX AS 15-60 130	130	R 1/2 / G 1	-	•	1 x 230 V
UPM3L					
UPM3L 15-75 130	130	R 1/2 / G 1	-	•	1 x 230 V
UPM3L FLEX AS 15-75 130	130	R 1/2 / G 1	-	•	1 x 230 V
UPMO					
UPMO 15-60 130	130	R 1/2 / G 1	•	•	1 x 230 V
UPMO 25-60 130	130	R 1 / G 1 1/2	•	•	1 x 230 V
UPMO 25-60 180	180	R 1 / G 1 1/2	•	•	1 x 230 V
UPMO 60 PH	-	-	-	•	1 x 230 V

Other versions or housings with different dimensions, materials, design or functionality are available on request. Please contact your Grundfos HVAC OEM KAM.

5. UPM external control mode and signals

Control principles

The UPM3 and UPM3 FLEX pumps are controlled via a digital low-voltage pulse-width modulation (PWM) signal which means that the speed of rotation depends on the input signal. UPM3 HYBRID pumps are controlled either internally or externally can be set to either internally or externally controlled. The speed changes as a function of the input profile. These communication signals are standardised in the VDMA Einheitsblatt 24244 "Wet runner circulating pumps - Specification of PWM control signals".

Control signals

Digital low-voltage PWM signal

The square-wave PWM signal is designed for a 100 to 4,000 Hz frequency range. The PWM signal is used to select the speed (speed command) and as feedback signal. The PWM frequency on the feedback signal is fixed at 75 Hz in the pump.

Duty cycle

$$d \% = 100 \times t/T$$

Example	Rating
$T = 2 \text{ ms}$ (500 Hz)	$U_{iH} = 4\text{-}24 \text{ V}$
$t = 0.6 \text{ ms}$	$U_{iL} \leq 1 \text{ V}$
$d \% = 100 \times 0.6 / 2 = 30 \%$	$I_{iH} \leq 10 \text{ mA}$ (depending on U_{iH})

Example

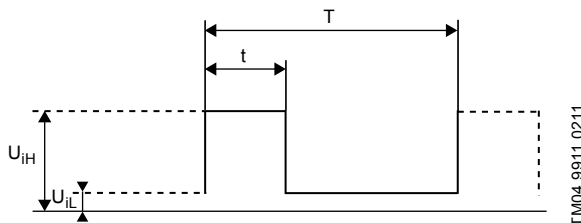

Fig. 12 PWM signal

Abbreviation	Description
T	Period of time [sec.]
d	Duty cycle [t/T]
U_{iH}	High-level input voltage
U_{iL}	Low-level input voltage
I_{iH}	High-level input current

Interface

The UPM3 PWM interface consists of an electronic part connecting the external control signal to the pump. The interface translates the external signal into a signal type that the microprocessor can understand.

In addition, the interface ensures that the user cannot get into contact with dangerous voltage if touching the signal wires when power is connected to the pump.

Note: "Signal ref." is a signal reference with no connection to protective earth.

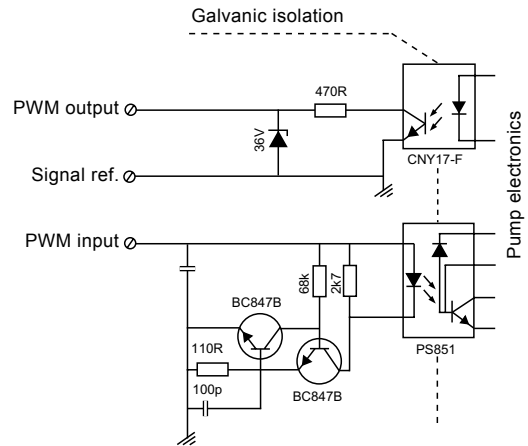
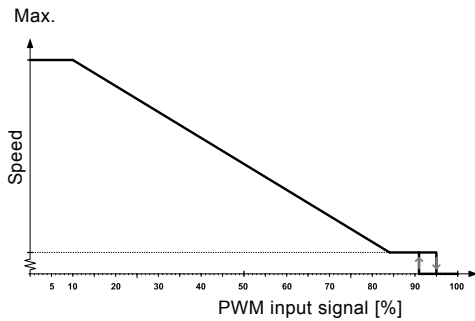

Fig. 13 Schematic drawing, interface

PWM input signal profile A (heating)

At high PWM signal percentages (duty cycles), a hysteresis prevents the pump from starting and stopping if the input signal fluctuates around the shifting point. At low PWM signal percentages, the pump speed is high for safety reasons. In case of a cable breakage in a gas boiler system, the pumps will continue to run at maximum speed to transfer heat from the primary heat exchanger. This is also suitable for heat pumps to ensure that the pumps transfer heat in case of a cable breakage.



TM04 9985 0311

Fig. 14 PWM input profile A (heating)

PWM input signal [%]	Pump status
≤ 10	Maximum speed: max.
> 10 / ≤ 84	Variable speed: min. to max.
> 84 / ≤ 91	Minimum speed: min.
> 91/95	Hysteresis area: on/off
> 95 / ≤ 100	Standby mode: off

PWM input signal profile C (solar)

At low PWM signal percentages (duty cycles), a hysteresis prevents the pump from starting and stopping if the input signal fluctuates around the shifting point. Without PWM signal percentages, the pump will stop for safety reasons. If a signal is missing, for example due to a cable breakage, the pump will stop to avoid overheating of the solar thermal system.

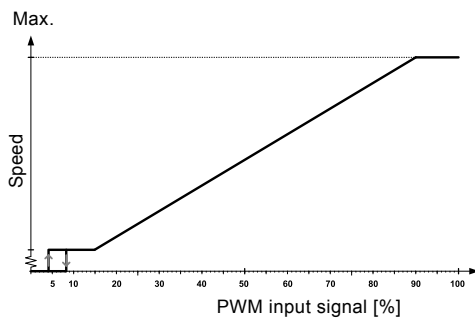

TM05 1575 3211

Fig. 15 PWM input profile C (solar)

PWM input signal [%]	Pump status
≤ 5	Standby mode: off
> 5 / ≤ 8	Hysteresis area: on/off
> 8 / ≤ 15	Minimum speed: min.
> 15 / ≤ 90	Variable speed: min. to max.
> 90 / ≤ 100	Maximum speed: max

PWM feedback signal - power consumption (standard)

The PWM feedback signal offers pump information like in bus systems:

- current power consumption (accuracy ± 2 % of PWM signal)
- warning
- alarm
- operation status.

Alarms

Alarm output signals are available because some PWM output signals are dedicated to alarm information. If a supply voltage is measured below the specified supply voltage range, the output signal is set to 75 %. If the rotor is locked due to deposits in the hydraulics, the output signal is set to 90 % because this alarm has a higher priority.

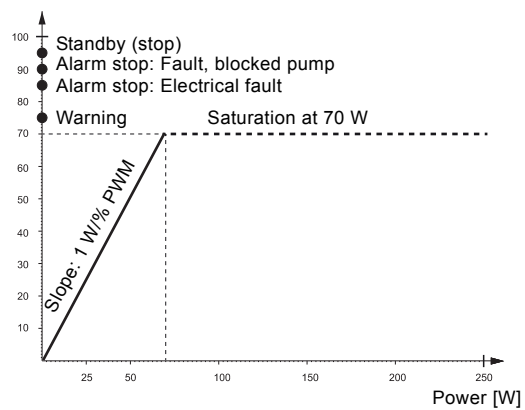

TM05 0006 0411

Fig. 16 PWM feedback signal, UPM3 power consumption

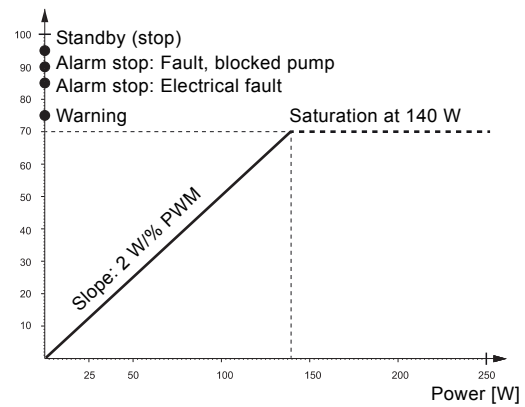

TM05 0021 0411

Fig. 17 PWM feedback signal, UPM3L power consumption

PWM output signal [%]	QT [s]	Pump info	DT [s]	Priority
95	0	Standby (STOP) by PWM signal	0	1
90	30	Alarm, stop, blocked error	12	2
85	0-30	Alarm, stop, electrical error	1-12	3
75	0	WARNING	0	5
0-70		0-70 W (slope 1 W/% PWM)		6

Output frequency: 75 Hz ± 5 %

QT = qualification time, DT = disqualification time

PWM feedback signal - flow estimation (on request)

On request, there is an option where the PWM feedback signal can also be used to indicate the flow of the pump on defined pump housings (e.g. cast iron inline) above a head of 1 m. The accuracy of the feedback signal is depending on the media, media temperature and operation point, but it gives an indication on the actual flow (see fig. 19).

Example: In this case the PWM output range between 0-70 % shows the flow between 0 and 2.1 m³/h with a slope of 0.03 m³/h / % PWM (see fig. 18).

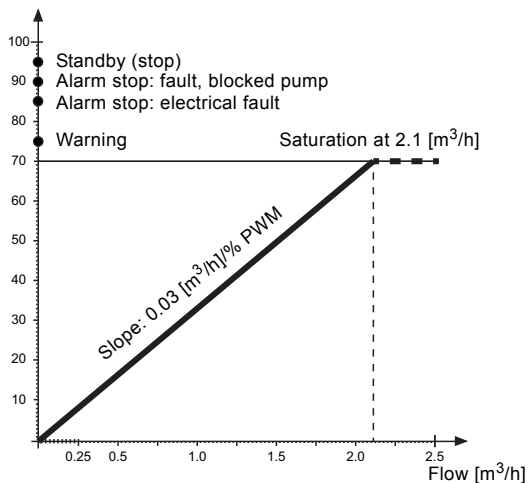

Fig. 18 PWM feedback signal - flow estimation

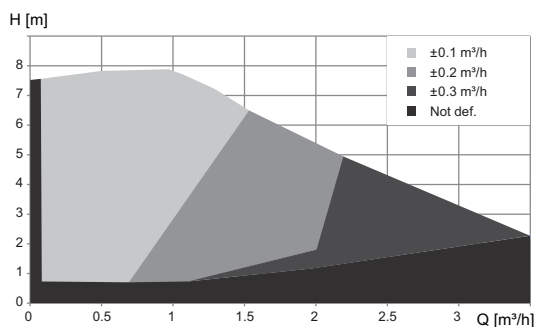

Fig. 19 Accuracy of PWM feedback signal - flow estimation with water at 20 °C

Data

Maximum rating	Symbol	Value
PWM frequency input with high-speed optocoupler	f	100-4000 Hz
Guaranteed standby power consumption		< 1 W
Rated input voltage - high level	U _{IH}	4-24 V
Rated input voltage - low level	U _{IL}	< 1 V
High-level input current	I _{IH}	< 10 mA
Input duty cycle	PWM	0-100 %
PWM frequency output, open collector	f	75 Hz ± 5 %
Accuracy of output signal regarding power consumption	-	± 2 % (of PWM signal)
Output duty cycle	PWM	0-100 %
Collector emitter breakdown voltage on output transistor	U _C	< 70 V
Collector current on output transistor	I _C	< 50 mA
Maximum power dissipation on output resistor	P _R	125 mW
Zener diode working voltage	U _Z	36 V
Maximum power dissipation in Zener diode	P _Z	300 mW

LIN bus (on request)

On request, there is an option of UPM3 with LIN bus communication. This data bus has been developed as a Local Interconnect Network (LIN) in the automotive sector and is used in vehicles.

"VDMA Einheitsblatt 24226" defines the specification of an appliance-integrated fieldbus system based on the LIN bus. With the LIN bus, serial data can be transmitted for control, monitoring and analysis.

Data transmitted from the LIN bus can be defined customised.

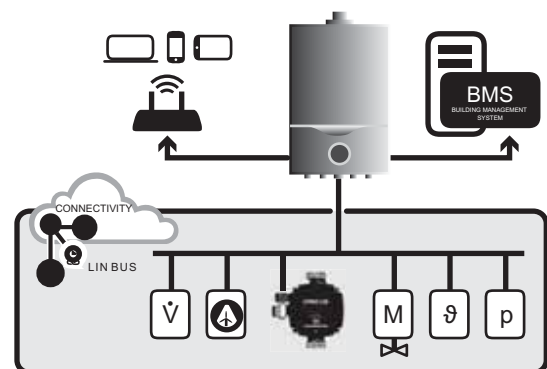

Fig. 20 LIN bus on fieldbus of heating control systems

Modbus (on request)

On request, there is an option of UPM3 with Modbus (RTU) communication.

6. UPM3 HYBRID control modes, user interface and settings

HYBRID control modes and curves

Up to five different control modes, each with up to four curves, are available for UPM3 HYBRID variants for different maximum heads.

Externally controlled		Internally controlled		
PWM A profile	PWM C profile	Proportional Pressure	Constant Pressure	Constant Curve
Curve 1	Curve 1	Curve 1	Curve 1	Curve 1
Curve 2	Curve 2	Curve 2	Curve 2	Curve 2
Curve 3	Curve 3	Curve 3	Curve 3	Curve 3
Curve 4 (MAX)	Curve 4 (MAX)	AUTO _{ADAPT}	AUTO _{ADAPT}	Curve 4 (MAX)

HYBRID variants

These setting options can be delivered as pre-configured variants.

Variant	Application	Functionality	Control modes and curves				Number of settings	Factory-preset
			Externally controlled		Internally controlled			
FLEX AS	Heating appliances	Runs with or without PWM signal. Without PWM signal, this pump runs on MAX curve.	PWM A	4	MAX	4	4	Depends on the pump type
SOLAR	Solar thermal systems	Runs with PWM C (solar) profile or on Constant Curve.	PWM C	4	CC	4	8	
DHW	Domestic hot water systems	Runs with or without PWM signal. Without PWM signal, this pump runs on MAX curve.	PWM A	4	MAX	4	4	
AUTO	Heating kits DHW system	Runs with all self-controlled modes and curves.			PP CP CC	3+AA 3+AA 4	12	
HYBRID	Any HVAC system	Runs with all available modes and curves.	PWM A PWM C	4 4	PP CP CC	3+AA 3+AA 4	20	

User interface

The user interface is designed with a single button, one red/green LED and four yellow LEDs.

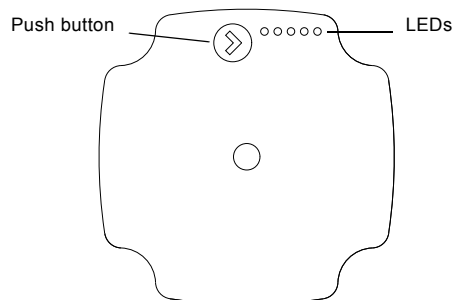

Fig. 21 User interface with one button and five LEDs

The user interface shows:

- performance view (during operation)
 - operation status
 - alarm status
- settings view (after pressing the button).

During operation, the display shows the performance view. If you press the button, the user interface switches the view or runs in the setting selection mode.

Performance view

The performance view shows either the operation status or the alarm status.

Operation status

When the pump is running, LED 1 is green. The four yellow LEDs indicate the current power consumption (P1) as shown in the table below. See fig. 22. When the operation mode is active, all active LEDs are constantly on in order to differentiate this mode from the select setting mode. If the pump is stopped by an external signal, LED 1 flashes green.

Display	Indication	Performance in % of P1 MAX
One green LED (flashing)	Standby (only externally controlled)	0
One green LED + one yellow LED	Low performance	0-25
One green LED + two yellow LED	Medium low performance	25-50
One green LED + three yellow LED	Medium high performance	50-75
One green LED + four yellow LED	High performance	75-100

Operation area

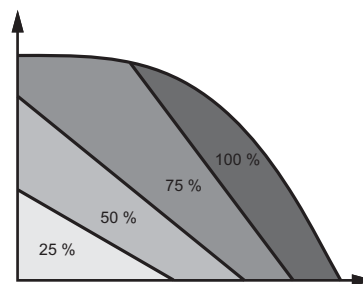

Fig. 22 Operation area according to performance load

Alarm status

If the pump has detected one or more alarms, the bicoloured LED 1 switches from green to red. When an alarm is active, the LEDs indicate the alarm type as defined in the table below. If multiple alarms are active at the same time, the LEDs only show the error with the highest priority. The priority is defined by the sequence of the table.

When there is no active alarm anymore, the user interface switches back to operation mode.

Display	Indication	Pump operation	Counter action
One red LED + one yellow LED (LED 5)	Rotor is blocked.	Trying to start again every 1.33 seconds.	Wait or deblock the shaft.
One red LED + one yellow LED (LED 4)	Supply voltage too low.	Only warning, pump runs.	Control the supply voltage.
One red LED + one yellow LED (LED 3)	Electrical error.	Pump is stopped because of low supply voltage or serious failure.	Control the supply voltage / Exchange the pump.

Settings view

You can switch from the performance view to the settings view by pressing the button. The LEDs indicate the actual setting. The settings view shows which mode controls the pump. No settings can be made at this stage. After 2 seconds, the display switches back to performance view.

If LED 1 is green, it indicates operation or internal control. If LED 1 is red, it indicates alarm or external control. LED 2 and 3 indicate the different control modes and LED 4 and 5 indicate the different curves.

	LED 1	LED 2	LED 3	LED 4	LED 5
Proportional Pressure	green	•			
Constant Pressure	green		•		
Constant Curve	green	•	•		
PWM A profile	red	•			
PWM C profile	red		•		
Curve 1					
Curve 2				•	
Curve 3				•	•
Curve 4/AUTOADAPT					•

Note: • = The LED is yellow.

Setting selection

You can choose between the performance view and settings view.

If you press the button for 2 to 10 seconds, the user interface switches to "setting selection" if the user interface is unlocked. You can change the settings as they appear. The settings appear in a particular order in a closed loop. When you release the button, the user interface switches back to the performance view and the last setting is stored.

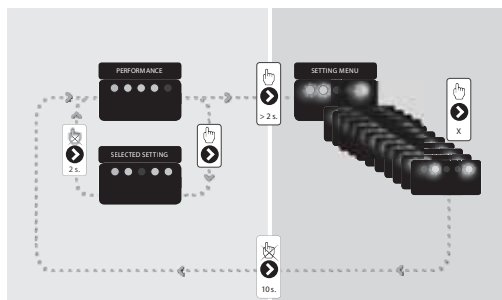

TM06 0856 1014

Fig. 23 Setting selection

User interface control modes for UPM3 HYBRID variants

All UPM3 HYBRID variants can be controlled with a single button and a LED interface.

The following operation modes can be selected with the button.

The user interface shows the flashing LEDs in the combination shown in the tables below.

UPM3 FLEX AS

This pump is either for external PWM A profile signal control or speed selection.

The maximum curve of the pump operation range can be defined.

- With PWM signal, the pump runs at the corresponding speed.
- Without PWM signal, the pump runs at maximum speed.

PWM A profile (heating)

PWM A profile	LED1 red	LED2 yellow	LED3 yellow	LED4 yellow	LED5 yellow
A1	•	•			
A2	•	•		•	
A3	•	•		•	•
A4 (max.)	•	•			•

UPM3 DHW

This pump is either for external PWM A profile signal control or speed selection.

The maximum curve of the pump operation range can be defined.

- With PWM signal, the pump runs at the corresponding speed.
- Without PWM signal, the pump runs at maximum speed.

PWM A profile (heating)

PWM A profile	LED1 red	LED2 yellow	LED3 yellow	LED4 yellow	LED5 yellow
A1	•	•			
A2	•	•		•	
A3	•	•		•	•
A4 (max.)	•	•			•

UPM3 SOLAR

This pump is either for external PWM signal control with profile C or internal control on Constant Curve mode.

Constant Curve mode

Constant Curve	LED1 green	LED2 yellow	LED3 yellow	LED4 yellow	LED5 yellow
CC1	•	•	•		
CC2	•	•	•	•	
CC3	•	•	•	•	•
CC4 (max.)	•	•	•		•

PWM C profile (solar)

PWM C profile	LED1 red	LED2 yellow	LED3 yellow	LED4 yellow	LED5 yellow
C1	•		•		
C2	•		•	•	
C3	•		•	•	•
C4 (max.)	•		•		•

UPM3 AUTO

This pump is for internal control with three control modes with $AUTO_{ADAPT}$.

Proportional Pressure mode

Proportional Pressure	LED1 green	LED2 yellow	LED3 yellow	LED4 yellow	LED5 yellow
PP1	•	•			
PP2	•	•		•	
PP3	•	•		•	•
PP AA	•	•			•

Constant Pressure mode

Constant Pressure	LED1 green	LED2 yellow	LED3 yellow	LED4 yellow	LED5 yellow
CP1	•		•		
CP2	•		•	•	
CP3	•		•	•	•
CP AA	•		•		•

Constant Curve mode

Constant Curve	LED1 green	LED2 yellow	LED3 yellow	LED4 yellow	LED5 yellow
CC 1	•	•	•		
CC 2	•	•	•	•	
CC 3	•	•	•	•	•
CC 4 (max.)	•	•	•		•

UPM3 HYBRID

This pump is either for external PWM signal control with profile A or C or internal control with three control modes with AUTO_{ADAPT}:

Proportional Pressure mode

Proportional Pressure	LED1 green	LED2 yellow	LED3 yellow	LED4 yellow	LED5 yellow
PP1	•	•			
PP2	•	•		•	
PP3	•	•		•	•
PP AA	•	•			•

Constant Pressure mode

Constant Pressure	LED1 green	LED2 yellow	LED3 yellow	LED4 yellow	LED5 yellow
CP1	•		•		
CP2	•		•	•	
CP3	•		•	•	•
CP AA	•		•		•

Constant Curve mode

Constant Curve	LED1 green	LED2 yellow	LED3 yellow	LED4 yellow	LED5 yellow
CC1	•	•	•		
CC2	•	•	•	•	
CC3	•	•	•	•	•
CC4 (max.)	•	•	•		•

PWM A profile (heating)

PWM A profile	LED1 red	LED2 yellow	LED3 yellow	LED4 yellow	LED5 yellow
A1	•	•			
A2	•	•		•	
A3	•	•		•	•
A4 (max.)	•	•			•

PWM C profile (solar)

PWM C profile	LED1 red	LED2 yellow	LED3 yellow	LED4 yellow	LED5 yellow
C1	•		•		
C2	•		•	•	
C3	•		•	•	•
C4 (max.)	•		•		•

UPMO

This pump is for internal control with three control modes CC, CP AUTO_{ADAPT}, PP AUTO_{ADAPT} or for external PWM signal control with profile A.

Constant curve / Radiator / UFH mode

Control mode	LED1 green	LED2 yellow	LED3 yellow	LED4 yellow	LED5 yellow
CC1	•				
CC2	•	•			
CC3	•	•	•		
RADIATOR	•			•	
UFH	•				•
PWM A Profile	•*				

* Flashing

Toggle the settings of UPM3

When you switch on the pump, it runs with the factory pre-setting or the last setting. The display shows the current operation status.

1. Press the button to switch to the setting view. The LEDs show the current setting for 2 seconds.
2. Release the button for more than 2 seconds. The user interface shows the current performance in "operation status".
3. Press the button for more than 2 seconds and the pump switches to "setting selection". The LEDs flash and show the current setting mode. Please note that if the key lock is disabled, the pump will not switch to "setting selection". In this case, unlock the key lock by pressing the button for more than 10 seconds.
4. During a period of 10 seconds, press shortly on the button and the pump switches to the next setting.
5. To select between the settings, instantly press the button until you find the setting you want. If you pass a setting, you need to continue until the setting appears again as it is not possible to go back in the settings menu.
6. Release the button for more than 10 seconds and the user interface switches back to the performance view and the last setting is stored.
7. Press the button and the display switches to the setting view and the LEDs show the current setting for 2 seconds.
8. Release the button for more than 2 seconds and the user interface switches back to the performance view.

Settings navigation

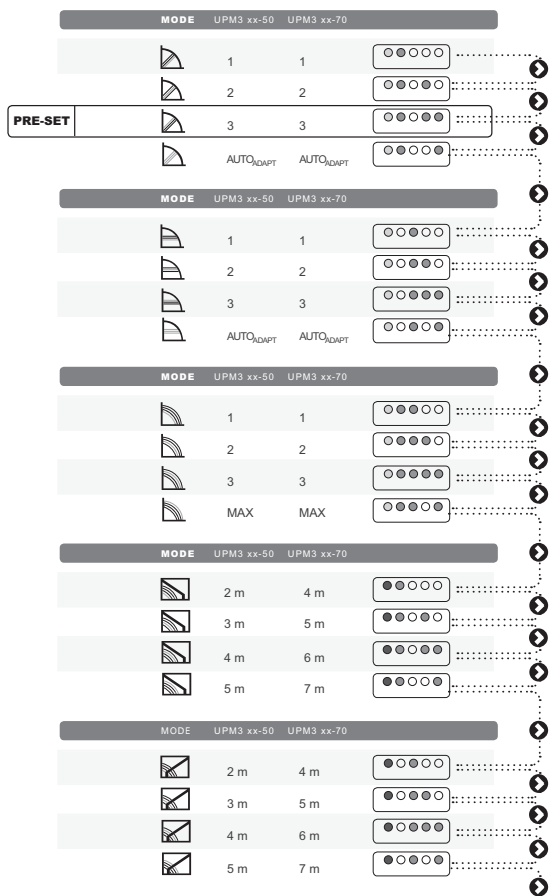

TM06 0551 0814

Fig. 24 Settings navigation

Control modes with pump curves

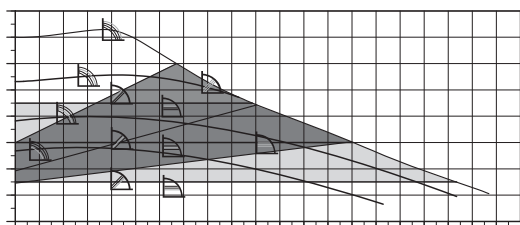

TM06 0803 0914

Fig. 25 UPM3 AUTO/HYBRID control modes with pump curves

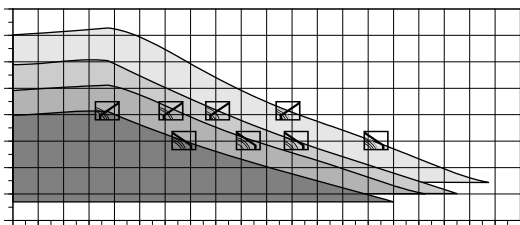

TM06 0804 0914

Fig. 26 UPM3 FLEX/HYBRID control modes with pump curves

Setting of UPMO

Every time you press the button, the pump setting is changed. A cycle is five button presses. To select the fixed EEI proportional curve (reg. EN 16297/ Part2), press and hold the button for 3 seconds.

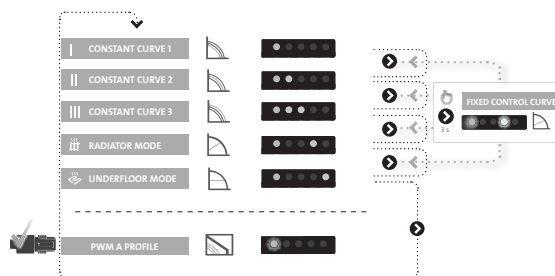

TM07 1357 1418

The pump automatically enables the PWM input-signal control mode by SignalDetect, when the signal cable is plugged in.

Control mode explanation

Proportional Pressure

The head (pressure) is reduced at falling heat demand and increased at rising heat demand.

The duty point of the pump will move up or down on the selected proportional-pressure curve, depending on the heat demand in the system.



TM06 0704 0814

- PP1: lowest proportional pressure curve
- PP2: intermediate proportional pressure curve
- PP3: highest proportional-pressure curve
- $AUTO_{ADAPT}$: highest to lowest proportional pressure curve.

The $AUTO_{ADAPT}$ function enables the pump to control the pump performance automatically within a defined performance range.

- Adjusting the pump performance to the size of the system.
- Adjusting the pump performance to the variations in load over time.

In Proportional Pressure $AUTO_{ADAPT}$ the pump is set to proportional-pressure control.

Constant Pressure

The head (pressure) is kept constant, irrespective of the heat demand.

The duty point of the pump will move out or in on the selected constant-pressure curve, depending on the heat demand in the system.



TM06 0705 0814

- CP1: lowest constant-pressure curve
- CP2: intermediate constant-pressure curve
- CP3: highest constant-pressure curve
- $AUTO_{ADAPT}$: highest to lowest constant-pressure curve.

The $AUTO_{ADAPT}$ function enables the pump to control the pump performance automatically within a defined performance range.

- Adjusting the pump performance to the size of the system.
- Adjusting the pump performance to the variations in load over time.

In Constant Pressure $AUTO_{ADAPT}$ the pump is set to constant-pressure control.

Constant Curve

The pump runs on a constant curve, which means that it runs at a constant speed or power.

The duty point of the pump moves up or down on the selected constant curve, depending on the heat demand in the system.



TM06 0805 0914

Constant Curve	UPM3 xx-20	UPM3 xx-50	UPM3 xx-70	UPM3 xx-75	UPM3 xx-105	UPM3 xx-145
CC1	0.5 m	2 m	4 m	4 m	4.5 m	6.5 m
CC2	1.0 m	3 m	5 m	5 m	6.5 m	8.5 m
CC3	1.5 m	4 m	6 m	6 m	8.5 m	10.5 m
CC4 (max.)	2.0 m	5 m	7 m	7.5 m	10.5 m	14.5 m

PWM A profile (heating)

The pump runs on constant speed curves depending on the current PWM value.

The speed decreases when the PWM value increases. If PWM equals 0, the pump runs at maximum speed.



TM06 0706 0814

PWM profile	UPM3 xx-20	UPM3 xx-50	UPM3 xx-70	UPM3 xx-75
A1	0.5 m	2 m	4 m	4 m
A2	1.0 m	3 m	5 m	5 m
A3	1.5 m	4 m	6 m	6 m
A4 (max.)	2.0 m	5 m	7 m	7.5 m
MAX	UPM3 xx-20	UPM3 xx-50	UPM3 xx-70	UPM3 xx-75
A1	0.5 m	2 m	4 m	4 m
A2	1.0 m	3 m	5 m	5 m
A3	1.5 m	4 m	6 m	6 m
A4	2.0 m	5 m	7 m	7.5 m

PWM C profile (solar)

The pump runs on constant speed curves depending on the current PWM value.

Speed will increase with increasing PWM value. If PWM equals 0, the pump stops.



TM06 0707 0814

PWM profile	UPM3 xx-50	UPM3 xx-70	UPM3 xx-75	UPM3 xx-105	UPM3 xx-145
C1	2 m	4 m	4 m	4.5 m	6.5 m
C2	3 m	5 m	5 m	6.5 m	8.5 m
C3	4 m	6 m	6 m	8.5 m	10.5 m
C4 (max.)	5 m	7 m	7.5 m	10.5 m	14.5 m

Pump control in heating systems

The heating required in a building varies greatly during the day due to changing outdoor temperatures, solar radiation and heat emanating from people, electric appliances, and others. In addition, the need for heating may vary from one section of the building to another and the thermostatic valves of some radiators may have been turned down by the users. An uncontrolled pump will produce a too high differential pressure when the heat demand and flow are low.

Possible consequences:

- too high energy consumption
- irregular control of the system
- noise in thermostatic radiator valves and similar fittings.

Grundfos UPM3 HYBRID and UPM3 AUTO automatically control the differential pressure by adjusting the pump performance to the actual heat demand, without the use of external components.

Advantages of pump control

In Grundfos UPM3 HYBRID and UPM3 AUTO pump control is effected by adapting the differential pressure to the flow (proportional-pressure and constant-pressure control). Contrary to an uncontrolled pump, a constant-pressure-controlled pump keeps the differential pressure constant. A proportional-pressure-controlled pump reduces the differential pressure as a result of falling heat demand.

For example:

If the heat demand falls, for instance due to solar radiation, the thermostatic radiator valves will close, and, for the uncontrolled pump, the flow resistance of the system will rise, for instance from A1 to A2.

In a heating system with an uncontrolled pump, this situation will cause a pressure rise in the system by ΔH_1 .

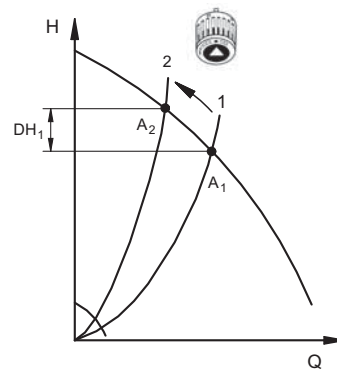

TM06 0857 1014

Fig. 27 Uncontrolled pump

In a system with a proportional-pressure-controlled pump, operated in the proportional pressure mode the pressure will be reduced by ΔH_2 and result in reduced energy consumption.

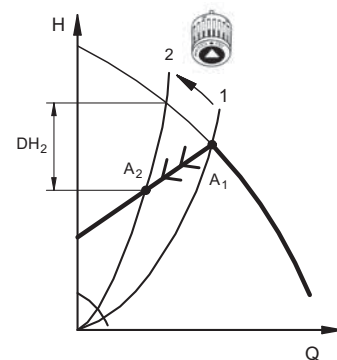

TM06 0858 1014

Fig. 28 Pump operated in proportional-pressure control mode

In a system with an uncontrolled pump, a pressure rise will often cause flow-generated noise in the thermostatic radiator valves. This noise will be reduced considerably with the proportional pressure control.

AUTO_{ADAPT}

Grundfos holds a patent for AUTO_{ADAPT} since 1995. With AUTO_{ADAPT}, the control curve is automatically adapted to the actual requirements of the respective application.

If you select AUTO_{ADAPT}, the pump starts with the medium proportional or constant control curve and runs on this curve as long as a new curve will be adapted.

The AUTO_{ADAPT} proportional pressure functionality is well known from millions of installed Grundfos trade pumps as ALPHA2 or MAGNA. The AUTO_{ADAPT} setting continually analyses and finds the setting where optimal comfort meets minimal energy consumption. It automatically delivers perfect comfort at the lowest possible energy level. It adapts to the requirements of the heating system before reaching the maximum pump curve and allows the pump to adjust the proportional pressure or constant pressure curve both up and down.

Advantages of AUTO_{ADAPT}

- Easy installation
- Automatic setting
- Demand-controlled operations
- Optimum comfort
- Energy savings
- Reduced CO₂ emissions.

Constant pressure at all load conditions is essential for how well the thermostatic valves can control the heat emission from the radiators. It is a well-known fact that optimum pump control in a two-pipe heating system with thermostatic radiator valves is best obtained by controlling pump pressure on a proportional pressure curve. In systems as underfloor heating or one-pipe systems it might be better to use Constant Pressure control. However, predicting the best position in real-life applications is rather difficult, because the optimum position depends on correlated factors such as the size of the heating system, the boiler type, the load condition, etc. This is where AUTO_{ADAPT} steps in to ensure that the pump is controlled in an optimum manner.

The AUTO_{ADAPT} algorithm

The objective of the AUTO_{ADAPT} algorithm is to measure and analyse the heating system during operation and adapt to the current heating pattern. The system adapts to night vs. day operations, summer vs. winter season, and heat losses or gains affecting room temperature, for example, from radiators, walls and windows, sun radiation, electrical equipment, and people.

AUTO_{ADAPT} three-step task

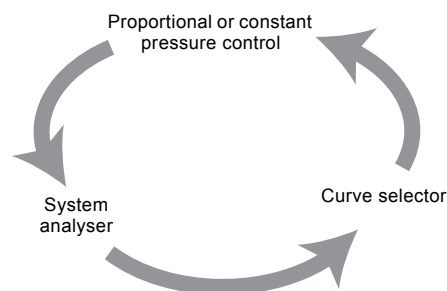

Fig. 29 The AUTO_{ADAPT} three-step task

Basically, AUTO_{ADAPT} optimises the position of the proportional or constant pressure curve via a three-step task as illustrated in fig. 29.

The "system analyser" analyses the heating system, which the pump is a part of. On the basis of the analysis, AUTO_{ADAPT} verifies whether the pump pressure is too high, too low, or correct. The "curve selector" then uses this knowledge to select the optimum proportional or constant pressure curve for the pump. Finally, the pump is controlled according to the selected proportional or constant pressure curve by means of the "Proportional Pressure or Constant Pressure control". The pump will continue this cycle as long as the pump is running.

TM06 0786 0914

Example

This example shows proportional pressure $AUTO_{ADAPT}$.

Note: The Constant Pressure $AUTO_{ADAPT}$ function acts accordingly just by utilising Constant Pressure control, and not Proportional Pressure control as shown in the example below.

The $AUTO_{ADAPT}$ function can operate and adjust pump speed according to duty point within a specific area.

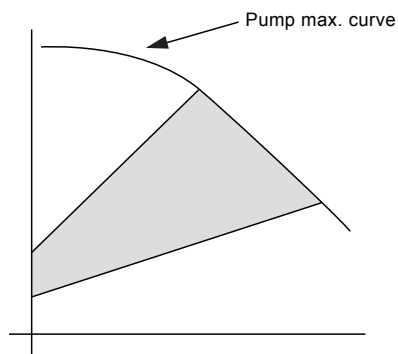

Fig. 30 Proportional pressure $AUTO_{ADAPT}$ operation area

As default the $AUTO_{ADAPT}$ is preset to operate the pump on the middle proportional pressure curve. By use of an immediate acting PI-controlling function the pump will adapt to the system on this proportional pressure curve.

Note: The PI controller is set to eliminate any offset within a time frame of 120 seconds.

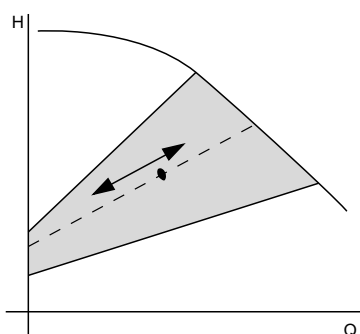

Fig. 31 Proportional pressure control

System analyser

From the preset reference duty point, the pump will immediately start to analyse the heating pattern.

The system resistance (K_{sys}) is logged and based on this data, a more optimal curve for operation is selected.

Note: $K_{sys} = m^3/h$ to create a system pressure loss of 1 bar.

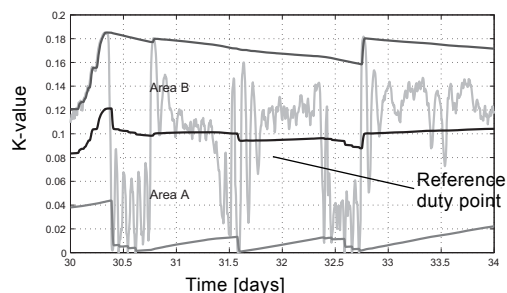

Fig. 32 K_{sys} -values logged for the system analyser

If the actual duty point deviates from the reference duty point over time, the pump will automatically adjust its performance accordingly. If a tendency of operation in area A is shown, the performance of the pumps is too high. The pump will then select a lower proportional pressure curve. In other words, if the requirement of the heating system exceeds the reference duty point, the pump will choose a higher proportional pressure curve. Should the requirement be lower, a lower curve will be chosen.

Curve selector

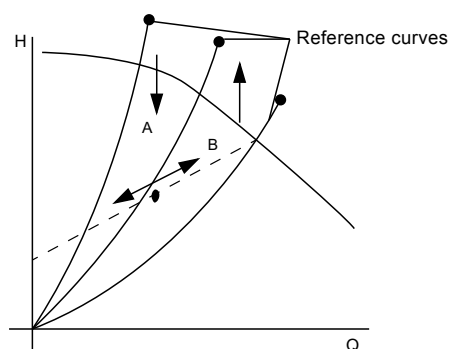

Fig. 33 Duty point on selected proportional pressure curve

Note: The arrows symbolise the change of the proportional pressure curve.

New reference setting

When changing the proportional pressure curve setting to adapt to the requirements of the heating system, $AUTO_{ADAPT}$ automatically sets a new reference duty point. From the new setting, the process starts over again: $AUTO_{ADAPT}$ will continuously adapt to changes in the heating pattern.

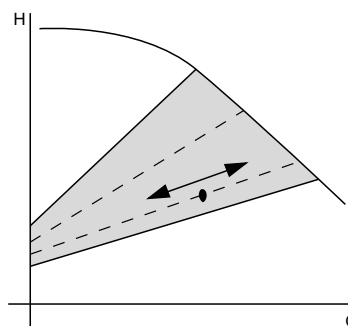







Fig. 34 New lower proportional pressure curve

Selection of control mode

The selection of the control mode depends on the system type and the allocation of pressure losses defined by the valve or consumer authority.

System type		Recommended control mode
Heating system with PWM control of the pump.		PWM A profile 
Solar system with PWM control of the pump.		PWM C profile 
System without PWM control of the pump (stand-alone).		Internally controlled
Variable-flow system with relatively high pressure losses inside heating appliance and pipes (> 50 % of pump head).	Two-pipe systems with thermostatic radiator valve with low valve authority. Primary pump.	$H_N > 2$ m for noise reduction. Long distribution pipes. High pressure losses in system parts with total flow. Heat consumers with low pressure losses. Primary circuit with high pressure losses. Proportional pressure / AUTO _{ADAPT} proportional pressure 
	Two-pipe systems with thermostatic radiator valve with high valve authority. Floor heating system with variable flow. One-pipe system with variable flow. Primary pump. Systems with low flow variation.	$H_N \leq 2$ m for noise reduction. Former gravity systems. Low pressure losses in system parts with total flow. Heat consumers with high pressure losses. System with thermostatic zone valves. System with thermostatic radiator valves. Primary circuit with low pressure losses. Systems with minimum flow ensured by an automatic bypass valve. Constant Pressure / AUTO _{ADAPT} Constant Pressure 
Constant flow systems		Constant Curve 

7. Technical description

Exploded view and sectional view

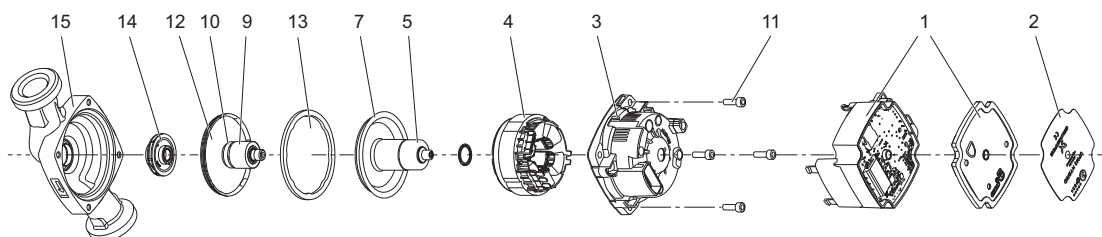

Fig. 35 UPM3 exploded view

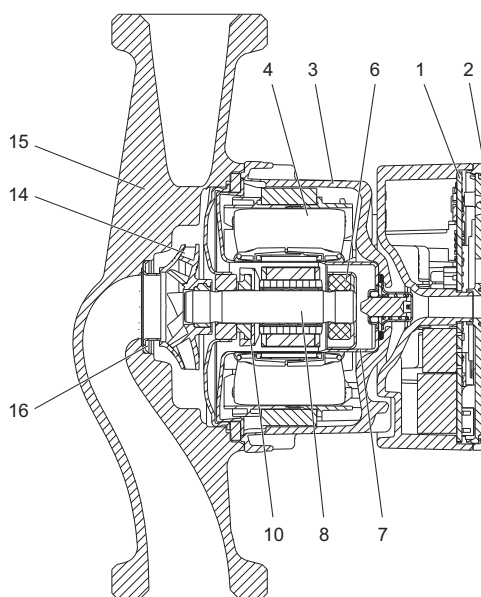

Fig. 36 UPM3 sectional view

Material specification

Pos.	Component	Material	EN/DIN
1	Control box	Composite PC-GF10 FR	
	Control electronics	PCB with SMD components	
	Control box heat sink	Aluminium	
2	Front foil	LEXAN 8A13F	
3	Stator housing	Aluminium, silumin	
4	Stator	Copper wire	
	Stator lamination	Laminated iron	
5	Push deblocking device		
	Plunger	Stainless steel	1.4404
	Spring	Stainless steel	1.4310
	Housing for spring	Stainless steel	1.4401
	Guide disc	Stainless steel	1.4401
	Housing for sealing	Stainless steel	1.4401
6	Sealing	EPDM	
	Radial bearing	Ceramics	
7	Rotor can	Stainless steel	1.4401

Pos.	Component	Material	EN/DIN
8	Shaft	Ceramics	
9	Rotor	NdFeB or injection-moulded ferrite	
	Rotor tube	Stainless steel	1.4521
	Rotor cladding	Stainless steel	1.4401/ 1.4301
	Bush	Stainless steel	1.4301
10	Thrust bearing	Carbon	
	Thrust bearing retainer	EPDM	
11	Screws	Steel, eco-lubric coated	
12	Bearing plate	Stainless steel	1.4301
13	Gasket	EPDM	
14	Impeller	Composite/PES 20 or 30 % GF	
		Cast iron GG15	EN-GJL-150
15	Pump housing	Stainless steel	1.4308
		Composite PA 6.6 30 %GF	
		Composite PPS 40 %GF	
16	Neck ring	Stainless steel	1.4301

TM05 9245 2415

TM05 9246 2415

Description of components

The Grundfos UPM3 pumps are of the canned-rotor type as pump and motor form an integral unit without shaft seal and with only one gasket for sealing and four screws for fastening the stator housing to the pump housing. The bearings are lubricated by the pumped liquid as the rotor can is filled with water. The focus has been on using eco-friendly materials as well as on limiting the number of materials.

Motor description

The efficiency of the three-phase, 4-pole, synchronous, electronically commutated permanent-magnet (ECM/PM) motor type is considerably higher compared to a conventional asynchronous squirrel-cage motor.

The ECM/PM motor is designed according to the canned-rotor principle. The design of the mechanical motor components has mainly focused on these features:

- reliable with stainless steel rotor can in one part and a specific formed EPDM gasket
- simple design meaning as few components as possible, each with several functions
- high efficient due to permanent magnets and low-friction bearings.

The motor is cooled by the pumped liquid which reduces the sound pressure level to a minimum. Being software-protected, the pump requires no further motor protection.

Stator housing

The aluminium die-cast stator housing with four fixing holes is following the design of the well-accepted Grundfos UP pumps. It enables easy change of motor positions by removing the four screws holding the stator housing and turning the housing to the desired position. There are two versions: one without drain hole as IP44, and one with one drain hole in two possible positions as IPX4D. During operation, the drain hole must always point downwards. UPM3 is IP44 as standard for non-condensing applications and IPX4D in UPM3 Solar. As K-variant for condensing applications, the stator housing IPX4D version is CED electrocoated.

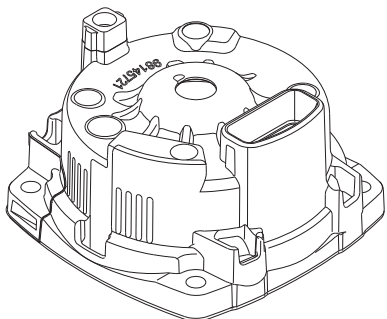

Fig. 37 Stator housing

TM05 9258 3613

Stator and windings

The UPM3 have a three-phase stator with six concentric positioned in-slot windings.

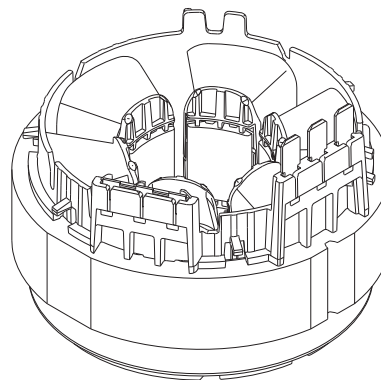

Fig. 38 Stator

TM05 9260 3613

Rotor can

The rotor can is drawn out of one sheet of stainless steel. It contains the ground and honed upper radial bearing. On top the rotor can has a hole on which the deblocking device is welded.

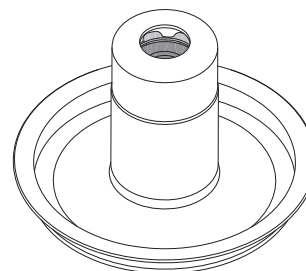

Fig. 39 Rotor can with bearing holder and ceramic bearing

TM05 9247 3613

Deblocking device

The deblocking device consists of an axial moving plunger tightened by an O-ring and pulled back by a spring inside a stainless steel housing that is welded to the rotor can. The deblocking device is designed for pumps integrated in appliances to give access to the shaft from the front of the pump without demounting the control box.

By pushing and turning a screw driver, Phillips No. 2, the plunger pushes the shaft in axial direction into the pump, while it can be turned as well. The force is high enough to deblock pumps which are seized by lime e.g. if an appliance is stored for months after being wet tested. Before, during and after the deblocking, the device is tight and must not release any water.

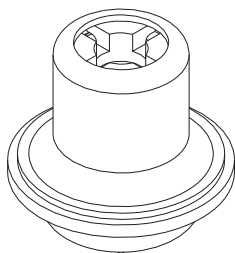

Fig. 40 Deblocking device

TM05 9253 3613

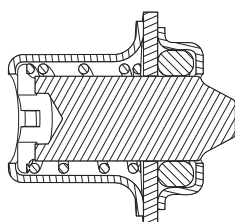

Fig. 41 Sectional drawing of deblocking device

TM06 02915013

Shaft with rotor

The shaft is made of ceramics. To avoid precipitation of calcium in the radial bearings, the shaft has been plunge-ground at the journal bearings. It has a through-going hole to ensure good lubrication and cooling of the upper bearing. The rotor can does not need to be vented as air inside the rotor chamber will escape the system through the through-going hole of the shaft.

The rotor core is either made of bonded neodymium permanent magnets, or injection-moulded with PPS bonded hard ferrite magnetic particles. The rotor is encapsulated in a thin stainless-steel cladding welded to the end covers. The rotor is fixed on the shaft by a back iron with a bush. After assembly the whole unit is balanced.

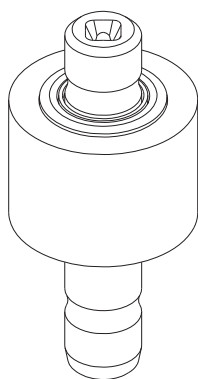

Fig. 42 Shaft with rotor

TM03 9250 3613

Thrust bearing

The antimony-free carbon thrust bearing is fitted to the shaft in a flexible EPDM retainer.

In combination with the bearing plate, the thrust bearing prevents forces from being transmitted axially to rotor and rotor can.

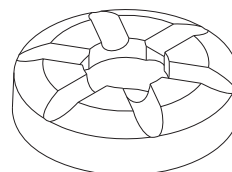

Fig. 43 Thrust bearing

TM05 9252 3613

Bearing plate

The bearing plate is made of stainless steel. The ground and honed inner radial and axial ceramic bearing is pressed into the bearing plate. The axial bearing is lapped to reduce any friction and the run in period of the pump. Due to the relatively large bearing plate surface, the motor heat is effectively carried away by the pumped liquid. Tiny laser holes through the bearing plate ensure optimum venting and minimise the gradual replacement of rotor liquid with the pumped liquid.

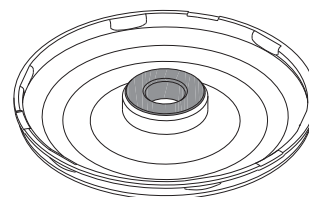

Fig. 44 Bearing plate with ceramic bearing

TM05 9249 3613

Impeller

The composite impeller is of the radial type with curved blades. The impeller shaft with rotor and bearing plate is assembled in one unit to eliminate possible misalignment in the bearings.

Three types of impellers are used:

- UPM3 Standard: diameter 38 mm, clearance 3 mm
- UPM3 SOLAR: diameter 52 mm, clearance 2.5 mm
- UPMO: diameter 48 mm, clearance 3 mm

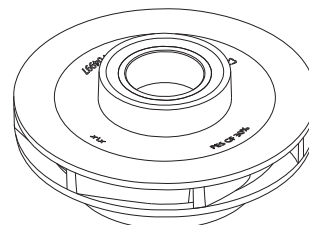
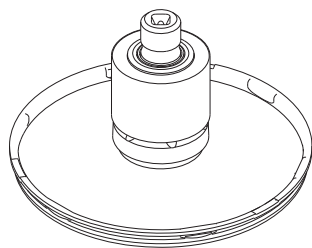

Fig. 45 Impeller

TM05 9251 3613

Moving unit

The unit is a pre-mounted combination of shaft with rotor, thrust bearing with retainer, bearing plate and impeller. The moving unit is inserted into the rotor can with the upper radial bearing. The unit runs as a bearing system, ceramic/ceramic, with almost no wear as long as it is lubricated. During production the unit is lubricated with glycerine. When the unit is mounted in a water-filled system, the system water lubricates the bearings. This guarantees the extremely reliable Grundfos ceramic bearing system of wet-running pumps.



TM05 9256 3613

Fig. 46 Moving unit

Gasket

The gasket is a formed flat O-ring made of EPDM, which is applicable for drinking water as well. The gasket seals up stator housing, pump housing, rotor can and bearing plate.

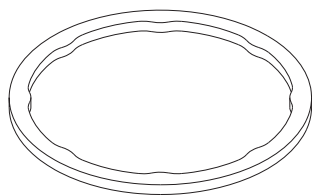

TM05 9257 3613

Fig. 47 Gasket



TM06 0846 1014

Fig. 48 Sectional drawing showing sealing principle of gasket

Pump housing

As a standard, the pump housing is available in electrocoated cast iron with threaded inlet and outlet ports. The reference pump housing is of the in-line type. The stainless-steel neck ring is pressed into the pump housing to minimise the amount of liquid running from the outlet side of the impeller to the inlet side. A wide range of OEM specific pump housings is available.

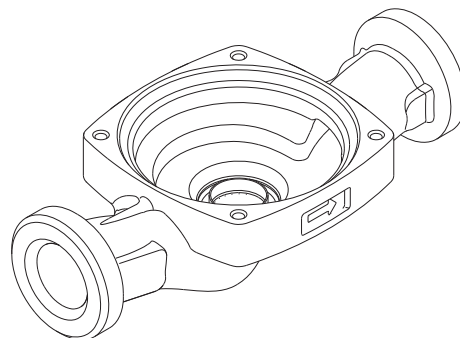

TM05 9254 3613

Fig. 49 Pump housing

Control box

The UPM3 control box housing is made of two composite parts welded together with an aluminium heat sink on top and covered by a front foil which cannot be removed. Power and signal connectors are integrated. There are two versions available with signal connection designed for Grundfos UPER/UPM connector or TE Mini Superseal connector.

The control box contains the PCBs for internal power supply, control and communication. The control box includes all relevant functions and EMC filter components. It is available with different hard- and software, mainly different regarding internal or external control, with or without user interface and communication signal as PWM.

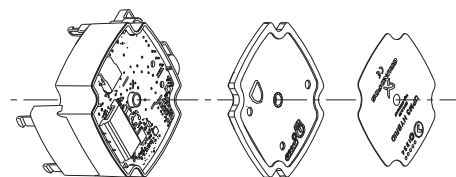

TM06 0826 1014

Fig. 50 Control box

UPM3 OEM specific housings

UPM3 pumps are available with a wide range of integrated standard housings or customised pump housings with different dimensions, in different materials, designs and with additional functionalities. Composite housings are mostly injection-moulded at the Grundfos factory using the tools designed and manufactured by Grundfos. The advantage of composite housings is the flexibility in forming complex housings and other hydraulic parts with low weight and production costs. Composite housings are limited to high-volume parts due to their high investment costs.

Cast-iron electrocoated (CED) in-line housings with threads



CED 15 x 130 mm

TM06 4423 2215



CED 25 x 130 mm

TM06 4424 2215



CED 25 x 180 mm

TM06 4425 2215



CED 32 x 180 mm

TM06 4426 2215

Stainless-steel (N) in-line housings with threads - approved for drinking water



NIRO 15 x 130 mm

TM06 8465 0717



NIRO 25 x 130 mm

TM06 4427 2215



NIRO 25 x 180 mm

TM06 4428 2215



NIRO 32 x 180 mm

TM06 4429 2215

Cast-iron electrocoated (CED) OEM housings - end-suction with threads or in-line with air outlet

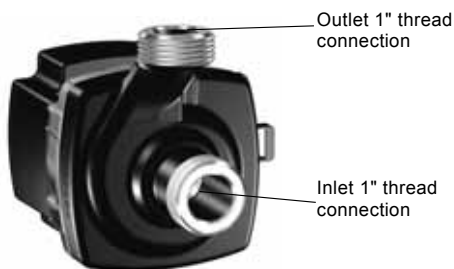

GGES cast-iron, end-suction

TM06 4430 2215

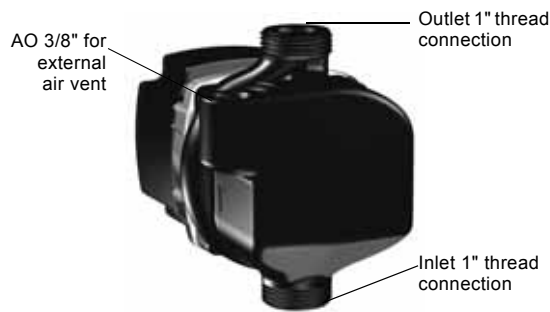

GGAOS3 cast-iron, inline with air outlet

TM06 8467 0717

Cast-iron electrocoated (CED) OEM housings - end-suction for back-panel mounting



GGMBP3 cast-iron, mini back-panel

TM06 4431 2215

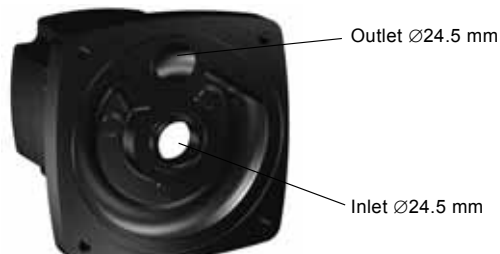

GGBP3 cast-iron, maxi back-panel

TM06 4432 2215

Composite in-line housings with threads, integrated vent and additional connections

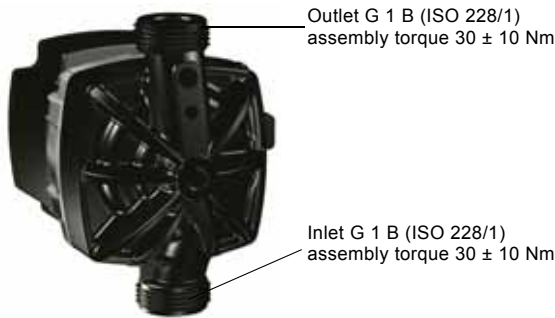

CIL3 composite, in-line, 1" x 130 mm

TM06 4433 2215

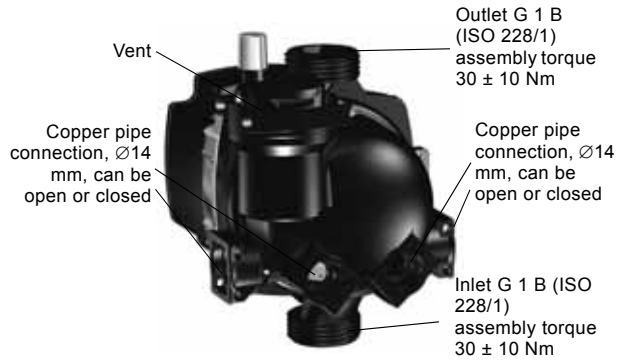

CACAO composite, alternate connection, air outlet

TM06 4434 2215

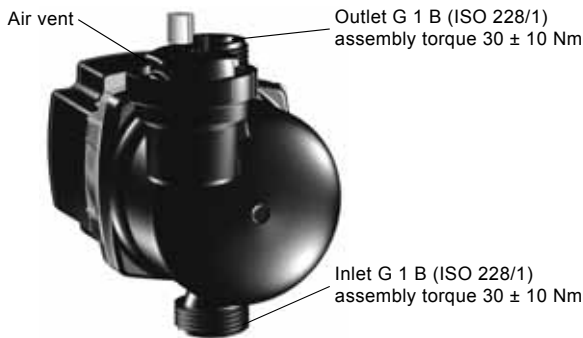

CIAO2 composite, in-line, air outlet

TM06 4435 2215

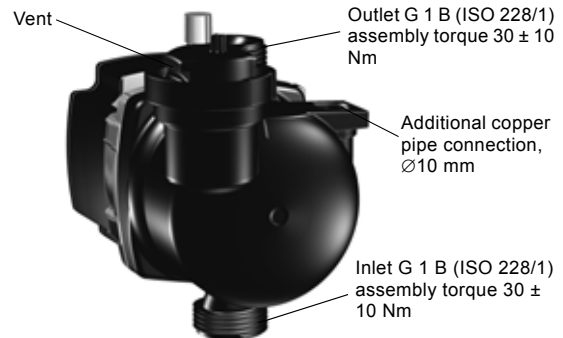

CIAO2 AC composite, in-line, air outlet, alternate connection

TM06 4436 2215

Composite end-suction housings with threads or clips, with integrated vent and special connections

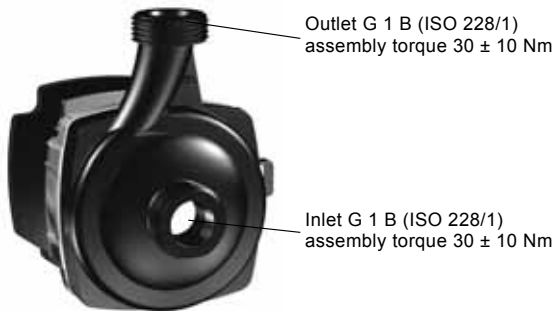

CES3 composite, end-suction

TM06 4437 2215

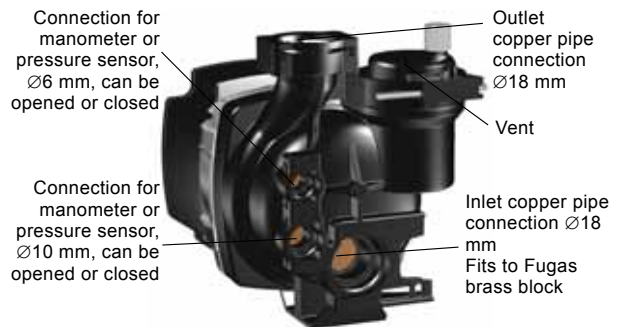

CESAO1 composite, end-suction, air outlet

TM06 4438 2215

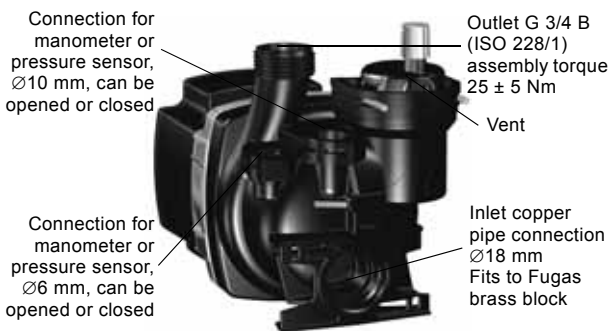

CESAO2 composite end-suction air outlet

TM06 4439 2215

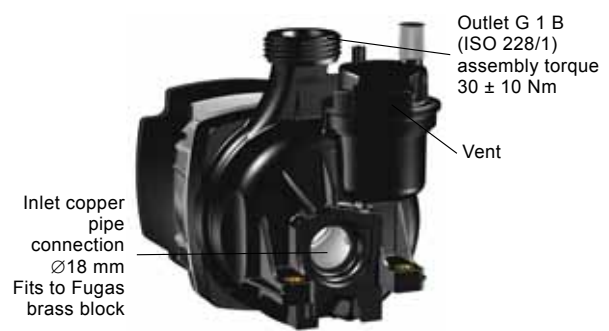

CESAO4 composite end-suction air outlet

TM06 4440 2215

Composite in-line housings with threads or clips, with integrated vent, drain and special connections

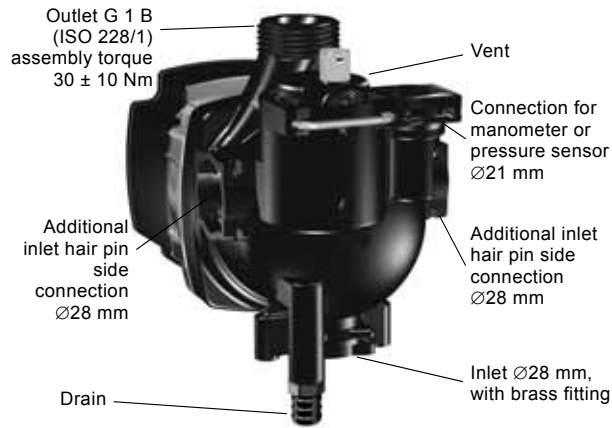

AOKR composite, air outlet, alternate connection, drain

TM06 4441 2215

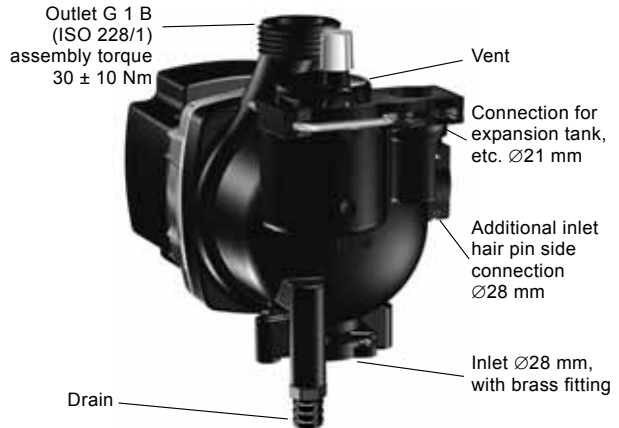

CAOD composite, air outlet, drain

TM06 4442 2215

Material	Type	Product number	GG cast iron	CED	N stainless steel	C PPS	C PA6.6	Weight [kg]	PN [bar]	Max. Temperature [°C]	Drinking water approvals				Port-to-port length [mm]				AO air vent integrated				
											IL in-line	ES end suction	BP back panel	DN	Inlet	Outlet	AC C1	AC C2	AC C3	AC C4	AO	D	
Cast iron CED PN 10	15 x 130 mm	98419166	●	-	-	-	-	0.7	10	130	-	●	-	-	15	130	G 1	G 1	-	-	-	-	-
	25 x 130 mm	98446965	●	-	-	-	-	0.9	10	130	-	●	-	-	25	130	G 1 1/2	G 1 1/2	-	-	-	-	-
	25 x 180 mm	98446967	●	-	-	-	-	1.0	10	130	-	●	-	-	25	180	G 1 1/2	G 1 1/2	-	-	-	-	-
	32 x 180 mm	98446970	●	-	-	-	-	1.2	10	130	-	●	-	-	32	180	G 2	G 2	-	-	-	-	-
Cast iron CED PN 10 for SOLAR	S 15 x 130 mm	97826565	●	-	-	-	-	0.8	10	130	-	●	-	-	15	130	G 1	G 1	-	-	-	-	-
	S 25 x 130 mm	97826550	●	-	-	-	-	0.9	10	130	-	●	-	-	25	130	G 1 1/2	G 1 1/2	-	-	-	-	-
	S 25 x 180 mm	97825980	●	-	-	-	-	1.1	10	130	-	●	-	-	25	180	G 1 1/2	G 1 1/2	-	-	-	-	-
Stainless steel PN 10	N 15 x 130 mm	98930212	-	●	-	-	-	1.0	10	130	●	●	-	-	15	130	G 1	G 1	-	-	-	-	-
	N 25 x 130 mm	98601971	-	●	-	-	-	1.0	10	130	●	●	-	-	25	130	G 1 1/2	G 1 1/2	-	-	-	-	-
	N 25 x 180 mm	98601972	-	●	-	-	-	1.2	10	130	●	●	-	-	25	180	G 1 1/2	G 1 1/2	-	-	-	-	-
	N 32 x 180 mm	98601973	-	●	-	-	-	1.4	10	130	●	●	-	-	32	180	G 2	G 2	-	-	-	-	-
Cast iron CED PN 10	GGES3	98648502	●	-	-	-	-	1.1	10	130	-	-	●	-	15	65	G 1	G 1	-	-	-	-	-
	GGBP3	98648481	●	-	-	-	-	1.7	10	130	-	-	-	●	15	117	24.5	25	-	-	-	-	-
	GGMBP3	98662017	●	-	-	-	-	1.2	10	130	-	-	-	●	15	90	26.0	19.0	-	-	-	-	-
	GGAOS3	98924189	●	-	-	-	-	1.3	10	130	-	●	-	-	15	130	G 1	G 1	-	-	-	-	Rp 3/8
PPS PN 10	CIL3 PPS	98560033	-	-	●	-	-	0.2	10	95	●	●	-	-	15	130	G 1	G 1	-	-	-	-	-
	CIL3 PA 6.6	98560032	-	-	-	●	-	0.2	3	95	-	●	-	-	15	130	G 1	G 1	-	-	-	-	-
Composite PA 6.6 PN 3 (customised versions not included, available on request)	CES3	98651949	-	-	-	●	-	0.1	3	95	-	-	●	-	15	87	G 1	G 1	-	-	-	-	-
	CIAO2	98650878	-	-	-	●	-	0.2	3	95	-	●	-	-	15	130	G 1	G 1	-	-	-	-	●
	CIAO2 AC	98650880	-	-	-	●	-	0.2	3	95	-	●	-	-	15	130	G 1	G 1	10	-	-	-	●
	CACAO	98095186	-	-	-	●	-	0.2	3	95	-	●	-	-	15	130	G 1	G 1	14	14	10	10	●
	CESAO1	98672445	-	-	-	●	-	0.2	3	95	-	-	●	-	15	94	18	18	6	10	-	-	●
	CESAO2	97992027	-	-	-	●	-	0.2	3	95	-	-	●	-	15	94	G 3/4	18	6	10	-	-	●
	CESAO4	98096544	-	-	-	●	-	0.3	3	95	-	-	●	-	15	87	G 1	18	-	-	-	-	●
	AOKR	59547502	-	-	-	●	-	0.3	3	95	-	●	-	-	15	128	G 1	28	28	28	21	-	●
CAOD	98763350	-	-	-	●	-	0.3	3	95	-	●	-	-	15	128	G 1	28	28	21	-	-	●	

Note:**Composite PA6.6 pumps with threaded flat sealings**

Since 1989, Grundfos has been manufacturing and selling pump housings and integrated hydraulic units of polymeric composite, primarily PA6.6 with 30 % glass-fibre reinforcement. When using composite, the optimal design of connections is clip or hair-pin, because of their low internal stress-generating level. For threaded connections, the full thread length must be used. The maximum assembly torque (e.g. 30 Nm \pm 10) is mentioned in the specifications of the pump. We recommend to use EPDM gaskets.

For reason of overload risk, Grundfos does not recommend to use composite threads for standalone connections outside appliances.

All PA6.6 housings are defined as integrated. For integrated pumps, the respective pump heads are tested according to EN 16297/3 on a reference housing.

Expected lifetime of composite PA6.6 housings

The expected lifetime of composite PA6.6 housings in heating applications depends on the liquid temperature and the system pressure. The liquid temperature must not exceed 95 °C, the system pressure must not exceed 3 bar (0.3 MPa). The expected lifetime also depends on the time/temperature profile of the application, based on which an equivalent constant liquid temperature can be calculated. The influence of the liquid temperature between 60 °C and 95 °C on the expected lifetime is shown in the following diagram.

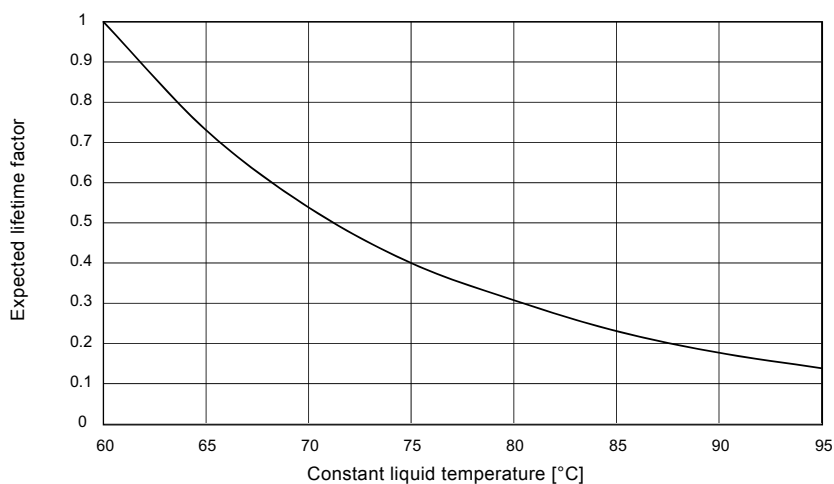

Fig. 51 Diagram temperature/expected lifetime for PA 6.6 30 % GF

TM06 4413 2215

Combination of housings and UPM3 control variants FLEX AS, SOLAR, DHW

UPM3 standard range		UPM3					FLEX AS			SOLAR			DHW		
Type		xx-75	xx-70	xx-60	xx-50	xx-40	xx-75	xx-70	xx-50	xx-145	xx-105	xx-75	xx-70	xx-50	xx-20
Max. H nom [m]		7.5	7	6	5	4	7.5	7	5	14.5	10.5	7.5	7	5	2
Max. P1 nom [W]		60	52	39	33	25	60	52	33	60	52	45	52	33	11
Cast iron CED, PN 10	15 x 130 mm	•	•	•	•	•	•	•	•	/	/	•	/	/	/
	25 x 130 mm	•	•	•	•	•	•	•	•	/	/	•	/	/	/
	25 x 180 mm	•	•	•	•	•	•	•	•	/	/	•	/	/	/
	32 x 180 mm	•	•	•	•	•	•	•	•	/	/	•	/	/	/
Cast iron CED, PN 10, for SOLAR	S 15 x 130 mm	/	/	/	/	/	/	/	/	•	•	/	/	/	/
	S 25 x 130 mm	/	/	/	/	/	/	/	/	•	•	/	/	/	/
	S 25 x 180 mm	/	/	/	/	/	/	/	/	•	•	/	/	/	/
Cast iron CED, PN 10, for UPMO	O 15 x 130 mm	/	/	/	/	/	/	/	/	/	/	/	/	/	/
	O 25 x 130 mm	/	/	/	/	/	/	/	/	/	/	/	/	/	/
	O 25 x 180 mm	/	/	/	/	/	/	/	/	/	/	/	/	/	/
Stainless steel, PN 10	N 15 x 130 mm	•	•	•	•	•	•	•	•	/	/	•	•	•	•
	N 25 x 130 mm	•	•	•	•	•	•	•	•	/	/	•	•	•	•
	N 25 x 180 mm	•	•	•	•	•	•	•	•	/	/	•	•	•	•
PPS, PN 10	CIL3 PPS	•	•	•	•	•	•	•	•	/	/	•	•	•	•
	GGES3	•	•	•	•	•	•	•	•	/	/	•	/	/	/
	GGBP3	•	•	•	•	•	•	•	•	/	/	•	/	/	/
Cast iron CE,D PN 10	GGMBP3	•	•	•	•	•	•	•	•	/	/	•	/	/	/
	GGAOS3	•	•	•	•	•	•	•	•	/	/	•	/	/	/
	CIL3 PA 6.6	○	○	○	○	○	○	○	○	/	/	○	/	/	/
Composite PA 6.6, PN 3★	CES3	○	○	○	○	○	○	○	○	/	/	○	/	/	/
	CIAO2	○	○	○	○	○	○	○	○	/	/	○	/	/	/
	CIAO2 AC	○	○	○	○	○	○	○	○	/	/	○	/	/	/
	CACAO	○	○	○	○	○	○	○	○	/	/	○	/	/	/
	CESAO1	○	○	○	○	○	○	○	○	/	/	○	/	/	/
	CESAO2	○	○	○	○	○	○	○	○	/	/	○	/	/	/
	CESAO4	○	○	○	○	○	○	○	○	/	/	○	/	/	/
	AOKR	○	○	○	○	○	○	○	○	/	/	○	/	/	/
	CAOD	○	○	○	○	○	○	○	○	/	/	○	/	/	/

★ Customised versions not included,
available on request

• Possible

/ Not possible

○ Possible for max. 95 °C

Combination of housings and UPM3, UPM3S, UPM3L, UPMO control variants AUTO, HYBRID

UPM3 standard range		AUTO		HYBRID		UPM3S				UPM3L		UPMO
Type		xx-70	xx-50	xx-70	xx-50	xx-60	xx-50	xx-40	FLEX AS xx-60	xx-75	FLEX AS xx-75	xx-60
Max. H nom [m]		7	5	7	5	6	5	4	6	7.5	7.5	7
Max. P1 nom [W]		52	33	52	33	42	34	25	42	75	75	60
Cast iron CED, PN 10	15 x 130 mm	•	•	•	•	•	•	•	•	•	•	/
	25 x 130 mm	•	•	•	•	•	•	•	•	•	•	/
	25 x 180 mm	•	•	•	•	•	•	•	•	•	•	/
	32 x 180 mm	•	•	•	•	•	•	•	•	•	•	/
Cast iron CED, PN 10, for SOLAR	S 15 x 130 mm	/	/	/	/	/	/	/	/	/	/	/
	S 25 x 130 mm	/	/	/	/	/	/	/	/	/	/	/
	S 25 x 180 mm	/	/	/	/	/	/	/	/	/	/	/
Cast iron CED, PN 10, for UPMO	O 15 x 130 mm	/	/	/	/	/	/	/	/	/	/	•
	O 25 x 130 mm	/	/	/	/	/	/	/	/	/	/	•
	O 25 x 180 mm	/	/	/	/	/	/	/	/	/	/	•
Stainless steel, PN 10	N 15 x 130 mm	•	•	•	•	•	•	•	•	•	•	/
	N 25 x 130 mm	•	•	•	•	•	•	•	•	•	•	/
	N 25 x 180 mm	•	•	•	•	•	•	•	•	•	•	/
	N 32 x 180 mm	•	•	•	•	•	•	•	•	•	•	/
PPS, PN 10	CIL3 PPS	-	-	-	-	•	•	•	•	•	•	/
Cast iron CED, PN 10	GGES3	•	•	•	•	•	•	•	•	•	•	/
	GGBP3	•	•	•	•	•	•	•	•	•	•	/
	GGMBP3	-	-	-	-	•	•	•	•	•	•	/
	GGAOS3	•	•	•	•	•	•	•	•	•	•	/
Composite PA 6.6, PN 3 ★	CIL3 PA 6.6	-	-	-	-	○	○	○	○	○	○	/
	CES3	-	-	-	-	○	○	○	○	○	○	/
	CIAO2	-	-	-	-	○	○	○	○	○	○	/
	CIAO2 AC	-	-	-	-	○	○	○	○	○	○	/
	CACAO	-	-	-	-	○	○	○	○	○	○	/
	CESAO1	-	-	-	-	○	○	○	○	○	○	/
	CESAO2	-	-	-	-	○	○	○	○	○	○	/
	CESAO4	-	-	-	-	○	○	○	○	○	○	/
	AOKR	-	-	-	-	○	○	○	○	○	○	/
	CAOD	-	-	-	-	○	○	○	○	○	○	/

★ Customised versions not included, available on request

• Possible
- Not available

○ Possible for max. 95 °C
/ Not possible

8. Installation



Installation must be carried out by trained persons in accordance with local regulations.

Pumped liquids



The pump must not be used for circulation of flammable liquids such as diesel oil and petrol.



Risk of malfunction or damage when inhibitors or additives are added to the pumped liquids.

The pump is suitable for the following liquids:

- Clean, thin, non-aggressive and non-explosive liquids, not containing solid particles or fibres.
- In heating systems, the water must meet the requirements of accepted standards on water quality in heating systems, for example the German standard VDI 2035.
- The pH must be between 8.2 and 9.5. The minimum value depends on the water hardness and must not be below 7.4 at 4 °dH (0.712 mmol/l).
- The electrical conductivity at 25 °C must be ≥ 10 microS/cm.
- Mixtures of water with antifreeze media such as glycol with a kinematic viscosity lower than 10 mm²/s (10 cSt). When selecting a pump, the viscosity of the pumped liquid must be taken into consideration. If the pump is used for a liquid with a higher viscosity, the hydraulic performance of the pump is reduced.
- Solar media as used in typical solar thermal systems containing up to 50 Vol % of antifreeze media.
- For drinking water systems, approved housings must be used, such as CIL3 PPS or stainless steel N. These pumps and their components in contact with water are approved by WRAS (GB), ACS (FR), KTW (DE) and DIN DVGW W270 (DE).
- In domestic hot-water systems, the pump must be used only for water with a degree of temporary hardness of less than 3 mmol/l CaCO₃ (16.8 °dH). To avoid lime problems in hard waters, the medium temperature must not exceed 65 °C.
- The water quality of test beds for the final production tests of complete heating appliances including pump must be observed to avoid calcification or biofilm formation during a longer storage period.

Mechanical installation



Mechanical installation must be carried out by trained persons in accordance with local regulations.



The pump must always be installed with horizontal motor shaft within $\pm 5^\circ$.



Arrows on the pump housing indicate the liquid flow direction through the pump. The pump is designed to be installed with horizontal shaft pumping upwards, downwards or horizontally.

For mounting dimensions see the data sheets.

- The pump must be installed in the system in such a way that no major amount of air flowing through or gathering in the pump housing affects the pump when it is out of operation.
- If an additional non-return valve is installed in the flow pipe, there is a high risk of dry-running, because the air cannot pass the valve.
- It must be possible to vent the system at the highest part of each system segment.
- Permanent venting is recommended.

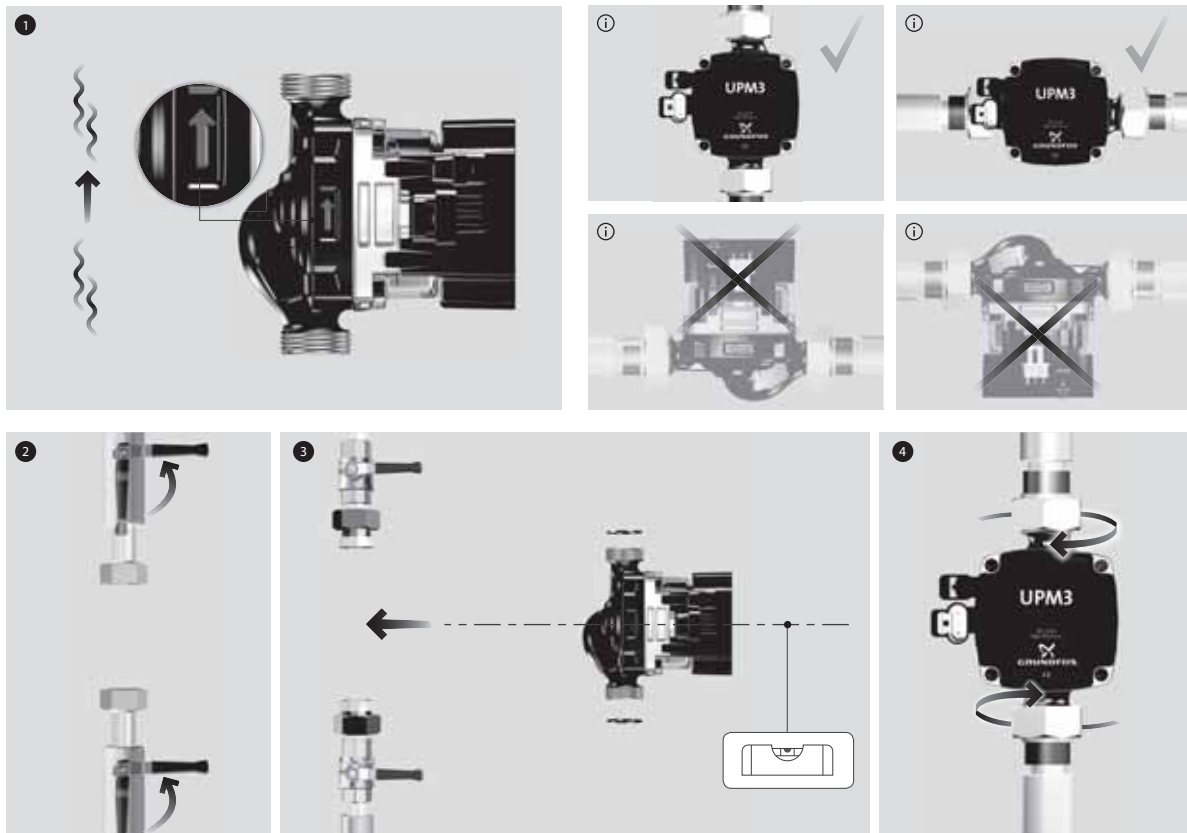

Fig. 52 Mechanical installation

TM06 4412 22 15

Control box positions

The terminal box has been designed to avoid the necessity of turning the terminal box, which gives access to the terminals from the front. If necessary, you can turn the pump head with terminal box in steps of 90 degrees to all four options. Please notice that you turn the user interface of the UPM3 HYBRID as well. As standard the user interface is on top (12 h), if the terminals are in position 9 h. You can choose to have the orientation of the front foil in four different positions. In this way, the nameplate is always in horizontal position when the pump is mounted.

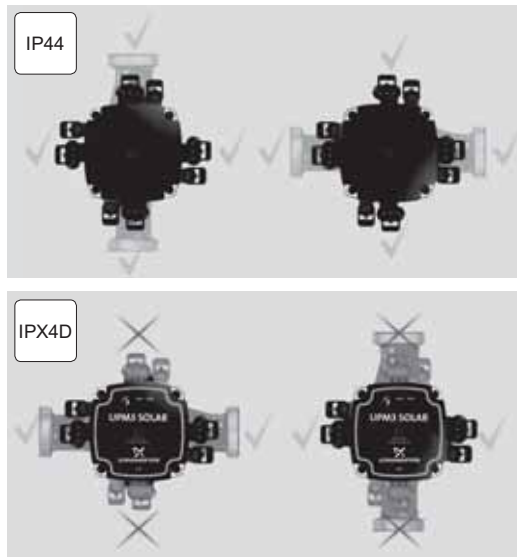

Fig. 53 Control box positions

Changing the control box position

1. Remove the screws that hold the pump head.
2. Turn the control box into the desired position.
3. Fit the screws.
4. Tighten the new screws securely.
 - The nameplate position cannot be changed.



Before dismantling the pump, drain the system, or close the isolating valves on either side of the pump.

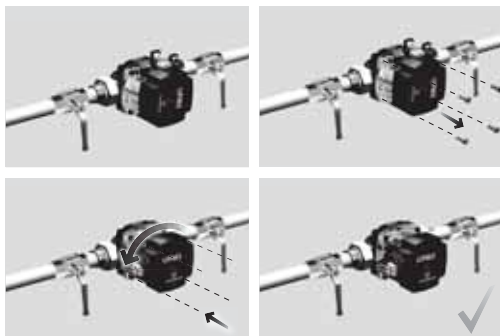

Fig. 54 Changing the control box position

Insulation

When insulating the pump, the front plate of the control box must not be covered in order to allow cooling by the surrounding air.

If the pump is installed inside a cabinet, a boiler or a heating kit encapsulated with insulation shells, the inside air temperature has to be evaluated and must not be higher than 70 °C during operation.

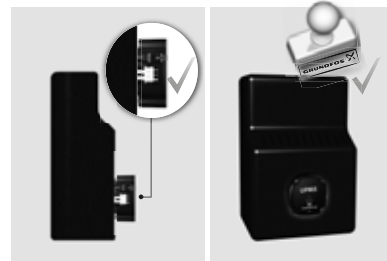

Fig. 55 Insulation of a pump

Ambient temperature

The ambient temperature must not exceed 70 °C (measured in a distance of not more than 5 cm in front of the front foil at its lower edge). The ambient temperature of UPM3L must not exceed 55 °C.

Relative humidity

IP44: The relative humidity must not exceed 95 % in a non-condensing environment.



The dew point of the air at ambient temperature should always be lower than the liquid temperature, otherwise condensation may form in the stator housing.

K-Version/IPX4D: Condensation is acceptable.

Storage temperature

-40 to +75 °C.

Liquid temperature

Note: For further lifetime evaluation, the temperature profile must be defined.

UPM3 with cast iron or stainless-steel housing:

- max. 110 °C at 70 °C ambient temperature
- max. 130 °C at 60 °C ambient temperature

UPM3 with composite housing (PA 6.6): max. 95 °C

UPM3L: max. 95 °C at 55 °C ambient temperature

UPM3, IP44 above dew point of ambient air: min. 2 °C

UPM3, IP4XD as K version with drain hole: min. -10 °C

Inlet pressure

To avoid cavitation noise and damage to the pump bearings, the following minimum pressures are required at the pump inlet port.

Liquid temperature	75 °C	95 °C	110 °C
Pressure	0.005 MPa 0.05 bar	0.05 MPa 0.5 bar	0.108 MPa 1.08 bar

TM06 4411 2215

TM06 4409 2215

TM06 4410 2215

Electrical installation

DANGER

Electric shock



- ▲ Death or serious personal injury
- ▶ Before starting any work at the pump, switch off the power supply. Make sure that the power supply cannot be switched on accidentally.



All electrical connections must be carried out by a qualified electrician in accordance with local regulations.



The pump is not a safety component and cannot be used to ensure functional safety in the final appliance.

- The pump requires no external motor protection.
- Check that the supply voltage and frequency correspond to the values stated on the nameplate.
- The pump must not be used with an external speed control which varies the supply voltage.
- If an earth leakage circuit breaker is used, check which type it is.
- If an external relay is used, check if it can stand the inrush current.

Supply voltage

1 x 230 V + 10 %/- 15 %, 50/60 Hz.

The UPM3 pumps are externally controlled via PWM signal or internally speed-controlled by a frequency converter. Therefore, the pumps must not be used with an external speed control which varies the supply voltage for example phase-cut or pulse-cascade control.

Reduced supply voltage

The pump operation is ensured above 160 VAC with reduced performance.

UPM3 with PWM control: If the voltage falls below the specified voltage range, a low voltage warning is sent via PWM return signal.

UPM3 in internal control mode: If the voltage falls below the specified voltage range, a low voltage warning is shown. If it falls below the minimum voltage, the pump stops and shows alarm.

Earth leakage circuit breaker (ELCB)

DANGER

Electric shock



- ▲ Death or serious personal injury
- ▶ If national legislation requires a Residual Current Device (RCD) or equivalent in the electrical installation, this must be type A or better, according to the nature of the pulsating DC leakage current.

If the pump is connected to an electric installation that uses an earth leakage circuit breaker (ELCB) as additional protection, this circuit breaker must trip when earth fault currents with DC content (pulsating DC) occur.

The earth leakage circuit breaker must be marked with the first (type A) or both (type B) of the symbols shown below:

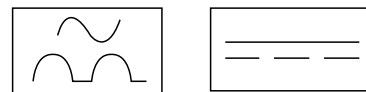

Fig. 56 Symbol on earth leakage circuit breaker

Leakage current

The pump mains filter will cause a leakage current to earth during operation.

Leakage current: < 3.5 mA.

High-voltage test

All Grundfos pumps are tested with 1000 VAC for 1 second according to EN 60335-1 Annex A.

ECM pumps incorporate filter components (including Y capacitors) that are connected to protective earth. The capacitors are class Y2 film capacitors with normal requirements. Every high-voltage test exposes the Y capacitors to high voltage.

The voltage level and the amount of tests should be as low as possible, in order to grant longest lifetime in the market. Additional standard high-voltage tests of the complete pump including filter should be avoided to eliminate the risk of filter damage.

TM05 5404

Inrush current

All electronic pumps contain electronic units that must be protected by filters including capacitors and ECM pumps frequency converters with AC/DC rectifiers containing capacitors to equalize the waves. This is not the case in most asynchronous pumps.

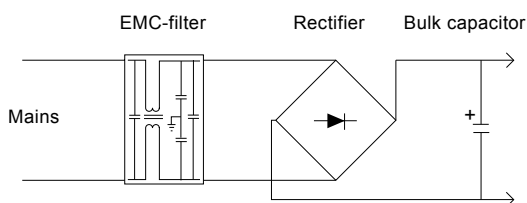

TM06 0822 1014

Fig. 57 Rectification of VAC voltage to DC voltage

The load of electronically commutated motors (ECM) behaves as a capacitive load and not as a motor load like in a standard pump.

At start, the capacitor is unloaded. Hereby the amplitude of the current peak depends on the grid impedance, until the capacitor is charged. The faster the capacitor is charged, the higher amplitude, and the faster the pump can be started. After this period of time, the current will drop to the rated current.

Definition: Inrush current is the current peak charging the capacitors in the electronics when the supply voltage is connected.

Note: When discussing measurements, it is important to refer to the same method. Since 2007, Grundfos uses the IEC 61000-3-3 Annex B method for measuring inrush current.

The inrush current peak charges the bulk capacitor to 325 VDC as fast as the power grid allows. That shows that inrush current is not only depending on the integrated electronics but as well on the impedance of the grid.

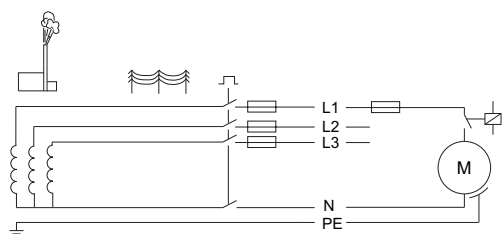

TM06 0819 1014

If you use a relay to switch the power supply of the pump, you risk excessive wear on the relay contact surface.

To avoid such problems there are different external and internal solutions.

External solutions in the controller of the appliance unit

- Specific relays with silver tin oxide (AgSnO_2) inrush relay contacts.
- Switching at ZERO crossing.
- Standby operation - pump only switches via the PWM signal.

Internal solutions in the pump

- NTC resistor in the power input circuit (passive)
- Bypass relay with PTC resistor or solid state inrush reduction controlled by the electronics (active)

UPM3 pumps are available with different hardware:

NTC resistor (passive option) (coming soon)

We recommend that you use this option for pumps that are permanently connected to the grid and switched on/off by external PWM signal.

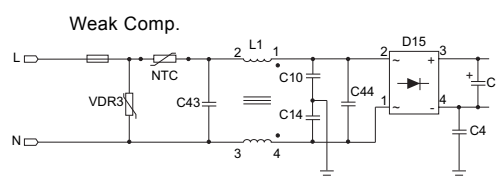

TM06 0820 1014

Fig. 58 NTC

At startup the operating temperature of the pump including the NTC resistor is cold. In this situation the NTC resistor has a high resistance and is able to limit the inrush current down to ~ 10 A.

During operation the operating temperature of the pump including NTC resistor is hot. There is no inrush current but the NTC resistance decreases so that the loss is limited.



At restart, the operator must ensure that the NTC resistor has been cooled down so that efficient operation is guaranteed. Normally, it takes 1 minute to cool down the resistor.

When the power supply to the pump is switched on and off via an external relay, you must ensure that the contact material of the relay is able to handle higher inrush currents.

Relay and PTC (active - standard for UPM3 HYBRID variants)

We recommend that you use this option for pumps that are not in permanent operation and can be interrupted by a relay of the controller of the appliance.

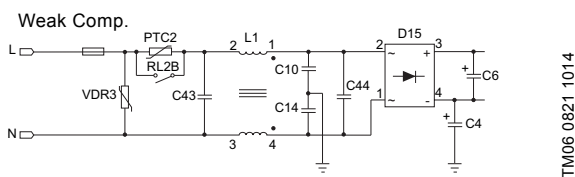

Fig. 59 NTC

At startup the relay is open. In this mode the PTC resistor is able to limit the inrush current down to a level of approximately 4 A.

During operation the relay is closed. In this mode the resistor is by-passed so that efficient operation is guaranteed.

Solid state inrush (SSI) current reduction (coming soon) (active - standard for UPM3 HYBRID variants)

We recommend that you use this option for pumps that are not in permanent operation and can be interrupted by a relay of the controller of the appliance.

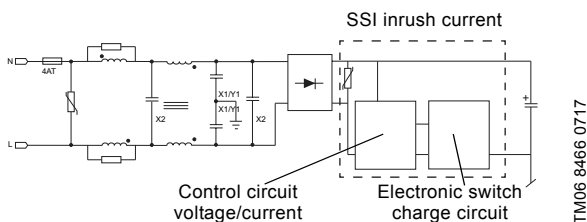

Fig. 60 SSI

The SSI (solid state inrush) hardware consists of two separate parts:

- Input coils at L and N for the reduction of the inrush from X capacitors in the input filter.
- Solid state inrush (SSI) circuit for the reduction of the inrush current from the DC-link capacitor.

The very fast current transients from charging the X capacitors are suppressed by the input coils. The SSI inrush circuit limits the maximum current to the DC-link capacitor. The current through the DC-link capacitor is monitored by the control circuit. The control circuit opens the electronic switch when the current limit is passed. Any current pulse, like surge pulses, is cut off. The SSI is autonomic self-controlled and has no delay or timing requirements. The SSI is able to limit the inrush current down to below 5 A.



The inrush current is measured on a flicker network according to IEC 61000-3-3:1994 + A1, + A2, Annex B.

Control box connections

All UPM3 control boxes have 2 electrical connections on one side: power supply and signal connection. If the signal connection is not needed (e.g. UPM3 AUTO (L)), it can be covered by a blind plug (available as an accessory). This is not mandatory for safety reasons.

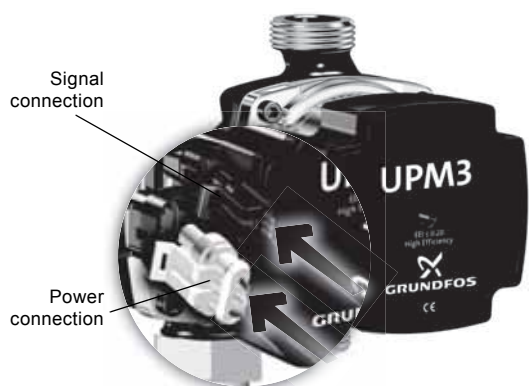

Fig. 61 Signal connection and power connection

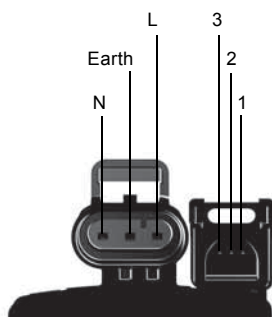

Fig. 62 Connections FCI

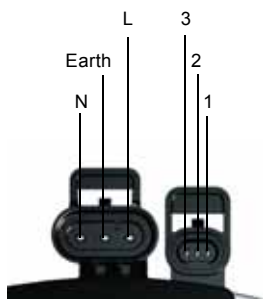

Fig. 63 Connections Mini SS

Contact	PWM	LIN	MOD	Cable
1	PWM input	LIN signal	B	Brown
2	Signal reference	Signal reference	Signal reference	Blue
3	PWM output	VBAT	A	Black

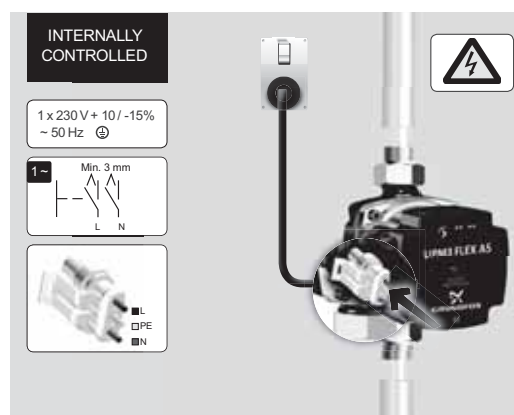

Fig. 64 Control box without signal connection

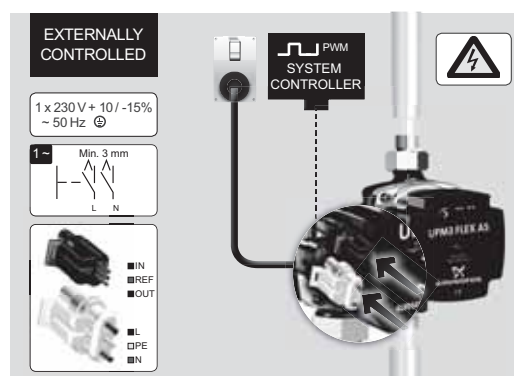

Fig. 65 Control box with Mini SS connection

Power supply connection

The pump must be connected to the power supply with the TE Superseal connector. Adapters are available for cables with Molex or Volex connectors.

TE Superseal power connector



Fig. 66 TE Superseal power connector

Reliability

- Temperature-proof and fireproof glow wire
- Waterproof

Safety

- Additional locking latch with pull-out force > 100 N
- Lock can only be opened with a screwdriver

Availability

- Worldwide as TE standard

Superseal installation plug

The Grundfos Superseal installation plug can be used to mount a supply cable locally. The Superseal installation plug incorporates cable relief and a locking function for securing the connection of the supply cable. The cover of the Superseal installation plug can be mounted in 2 different positions, with the cable relief away from the pump or in parallel.

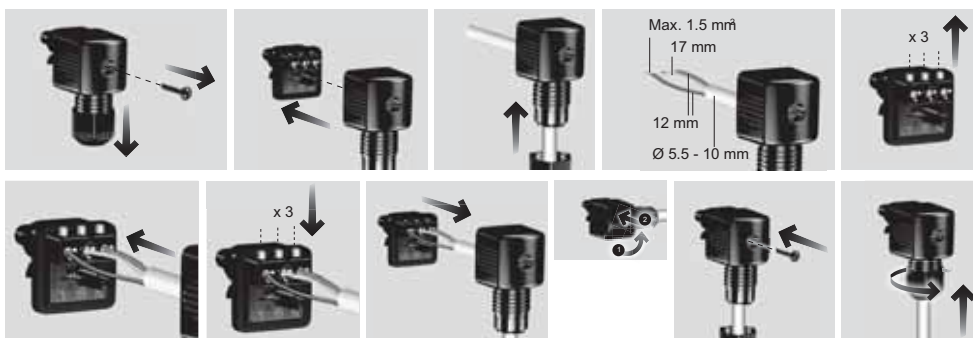

TM06 8447 0617

Fig. 67 Superseal installation plug

Control signal connection



Connect the signal wires to the correct poles. Otherwise the pump might be damaged.

UPM3 pumps are externally speed-controlled. A signal cable is required to enable the pump control. Otherwise the pump with profile A runs continuously at maximum speed, the pump with profile C stops.

UPM3 HYBRID pumps are either internally or externally speed-controlled.

If you set the pump to external control mode (PWM A or C profile) via the user interface, you need a signal cable. If you set the pump to internal control mode, a blind plug is available to close the signal connection. The plug is not required for safety reasons.

The signal cable connection has three leads: signal input, signal output and signal ref. The cable must be connected to the control box either by FCI or TE Mini Superseal connector. The optional signal cable can be supplied with the pump as an accessory.

The cable length can be customised to specific requirements (max. 3 m).

TE Mini Superseal connector



Fig. 68 TE Mini Superseal connector

TM06 4414 2215

Safety

- Additional locking latch with pull-out force > 100 N
- Lock can only be opened with a screwdriver

Availability

- Worldwide as TE standard

Grundfos FCI (for UPER/UPM)

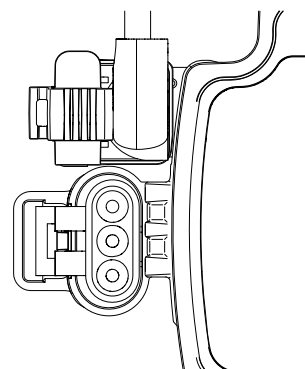

Fig. 69 Grundfos FCI for UPER/UPM

TM06 4417 2210

Backwards compatibility

- For replacement of UPER/UPM pumps or in appliances that use FCI plug, e.g. cable trees

Safety

- Two-part design: separate lock is needed to meet the pull-force requirements > 100 N

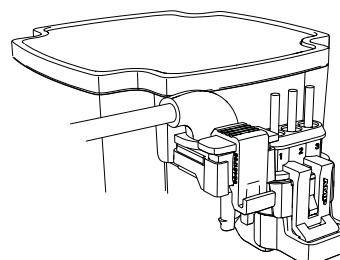

Fig. 70 FCI signal cable fixed by a separate lock

TM06 4418 2215

Availability

- Many cable suppliers use these cable connections.

Overview of technical data

Feature	Specification
Nominal supply voltage	EU: 1 x 230 V + 10 %/- 15 %, 50/60 Hz
Minimum supply voltage	160 VAC (runs with reduced performance)
Motor protection	The motor is protected by the electronics in the control box and requires no external motor protection.
Enclosure class	IP44 (standard without drain holes). K-version: IPX4D (with drain holes)
Equipment class	I (EN 60335-1)
Insulation class	F (EN 60335-1)
Temperature class	TF110 at 70 °C ambient temperature UPM3L: TF95 at 55 °C ambient temperature
High voltage protection	EN 60335-1 1000 VAC
Maximum ambient temperature	70 °C at 110 °C or 60 °C at 130 °C. UPM3L: 55 °C at 95 °C.
Maximum media temperature	95 °C for composite housings, 110 °C/130 °C for cast iron housings
Minimum media temperature	2 °C (IP44: above dew point of ambient air). K version: -10 °C.
Storage temperature	-40 to +75 °C
Maximum system pressure	1 MPa (10 bar) (depending on the housing material)
Minimum inlet pressure	0.005 MPa (0.05 bar) at 75 °C liquid temperature 0.05 MPa (0.50 bar) at 95 °C liquid temperature 0.108 MPa (1.08 bar) at 110 °C liquid temperature
Flow estimation	Available depending on the housing, accuracy: see PWM specification
Drinking water approvals (ACS, WRAS, UBA, KTW, DVGW W270)	All pump head components are compliant, except for UPM3S. Specific compliant pump housings are available.
Deblocking device	Manual deblocking device, access from front side
Deblocking software	Continuously restarting with relay after 1.33 seconds, with NTC/SSI every 0.3 - 0.4 seconds with max. torque
Dry run ability - first start	3 x 20 seconds (5 minutes interval), all pumps are lubricated with glycerine
Dry run ability - during operation	Rotor can must be filled with water: fulfils EN 60335-2-51
Expected lifetime	> 100,000 h (with specified load profile) > 500,000 on/off cycles
Minimum switching time power on/off	With NTC: 1 minute. With relay/SSI: No specific requirements.
Reaction time - power on	With relay: 3.3 seconds, with NTC/SSI < 1 second
Reaction time - standby	With relay: 1.5 seconds, with NTC/SSI < 1 second
Reaction time - speed change	< 1 second
Inrush current	With NTC: < 10 A. With SSI: < 5 A. With relay: < 4 A.
Maximum leakage current	≤ 3.5 mA (EN 60335-1)
Speed range	563 to 5991 min ⁻¹ (depending on the variant)
Relative humidity	Maximum 95 %, non-condensing environment.
Standby power consumption	With relay < 2 W, with NTC/SSI < 0.3 W
Surge robustness	With relay/NTC > 3 kV (DM/CM), with SSI > 4 kV (DM/CM)
Surge robustness (SSI version)	> 4 kV (DM/CM)
RF emissions	-6 dB CE / EN 55014-1,-2
Acoustic sound pressure level	≤ 43 dB(A), ≤ 32 dB(A) reg. ISO 3745:2012 on cast iron housings
Maximum altitude of installation	2000 m above sea level

9. Startup

Before you start the UPM3 pump:

1. Mount the pump in the right way (see 8. *Installation*).
2. Check that the unions are tightened.
3. Check that the valves are opened.
4. Fill the system and vent it above the pump.
5. Check if the required minimum inlet pressure is available at the pump inlet.
6. Switch on the power supply.
7. If the pump is externally controlled: Check if the external controller sends a signal that controls the speed or that might have stopped the pump.
8. If the pump is internally controlled: The pump starts with factory pre-setting (e.g. proportional pressure curve 3). Change the setting if necessary (see *User interface*).



Do not start the pump, until the system has been filled with liquid and vented.



UPM3 pumps are self-venting and do not have to be vented before startup. Air inside the pump is transported by the liquid into the system shortly after startup.

Hint for installers:

- Heating systems must be flushed according to local standards, such as DIN EN 14336 or VOB ATV C DIN 18380, before startup. After filling the system for the first time, the pump must run for approx. 1 hour before a long-term stop.
- Inhibitors and additives increase the risk of malfunction of the pump.
- If filters are installed, they must be monitored and maintained thoroughly.

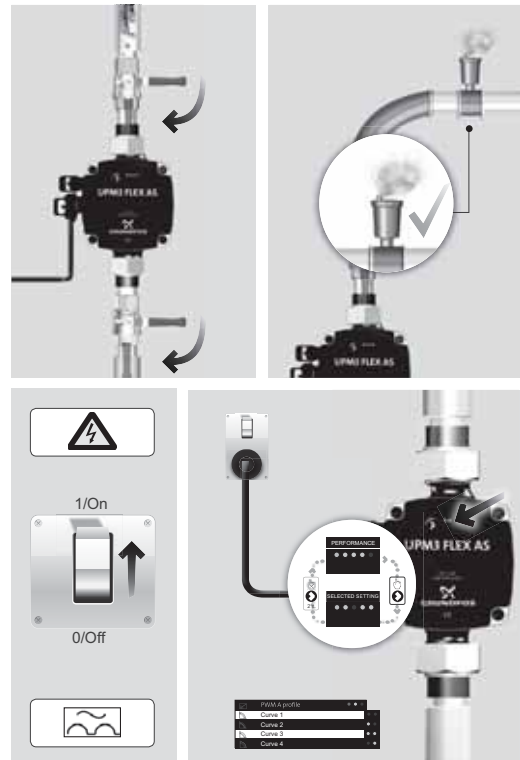

TM06 4406 2215

Warning: This appliance can be used by children aged from 8 years and above and persons with reduced physical, sensory or mental capabilities or lack of experience and knowledge, if they have been given supervision or instruction concerning use of the appliance in a safe way and understand the hazards involved. Children shall not play with the appliance. Cleaning and user maintenance shall not be made by children without supervision.

Hint for OEM customers: This warning must be available in the local language when placing the product on the market. It is part of the Quick Guides.

10. Service

DANGER

Electric shock



- ▲ Death or serious personal injury
- ▶ Before starting any work at the pump, switch off the power supply. Make sure that the power supply cannot be switched on accidentally.
- ▶ Be aware that capacitors will be live up to 30 seconds after the power supply has been switched off.

DANGER

Electric shock



- ▲ Death or serious personal injury
- ▶ Before dismantling the complete pump set, switch off the power supply at least 5 minutes prior to commencing work and ensure that it cannot be switched on again unintentionally.

DANGER

Electric shock



- ▲ Death or serious personal injury
- ▶ When running in reverse, the pump acts as a generator and creates hazardous induction voltage at the motor terminals.
- ▶ Prevent the fluid from flowing back by closing the shut-off valves.

WARNING

Strong magnetic field in the rotor area



- ▲ Danger of death for persons with pacemaker.
- ▶ Keep a safety distance of at least 0.3 m during disassembly.

WARNING

Toxic material



- ▲ Death or serious personal injury
- ▶ Decontaminate pumps which handle fluids posing a health hazard.

CAUTION

Hot surface



- ▲ Minor or moderate personal injury
- ▶ Before starting to work on the pump, let the pump casing cool down to ambient temperature.



All service work must be carried out by an instructed service technician.



Before dismantling the pump, drain the system, or close the isolating valves on either side of the pump.

Maintenance

UPM3 pumps are maintenance-free. However, it might be necessary to deblock or to open the pump, for example if it is blocked by impurities.

Deblocking is possible by opening the deblocking screw at the front.

1. Unscrew the deblocking screw at the front of the pump head.
 - Be aware of splashing hot water.
2. Dblock the pump with a screwdriver.

Cleaning

If the impeller or pump housing has to be cleaned from impurities, proceed as follows:

1. Drain the system or close the isolating valves.
 - Be aware of hot water.
2. Remove the screws that hold the pump head.
3. Check impeller and pump housing and remove the impurities.
4. Place the pump head in the desired position, fit the screws and tighten the screws securely.

Fault finding

Fault	Cause	Remedy
1. Pump is not running. No power supply.	• System is switched off.	Check the system controller.
	• A fuse in the installation is blown.	Replace the fuse.
	• The circuit breaker has tripped.	Check the power connection and switch on the circuit breaker.
	• Power supply failure.	Check the power supply.
2. Pump is not running. Normal power supply.	• Controller is switched off.	Check the controller and its settings.
	• Pump is blocked by impurities.	Remove impurities. Unblock the pump from the front of the control box with a screwdriver.
	• Pump is defective.	Replace the pump.
3. Pump runs at maximum speed and cannot be controlled.	• No signal from signal cable.	Check if the cable is connected to the controller. If it is, replace the cable.
4. Noise in the system.	• There is air in the system.	Vent the system.
	• Differential pressure is too high.	Reduce the pump performance at the pump or external controller.
5. Noise in the pump.	• There is air in the pump.	Let the pump run. The pump vents itself over time.
	• Inlet pressure is too low.	Increase the system pressure or check the air volume in the expansion tank, if installed.
6. Insufficient flow.	• Pump performance is too low.	Check the external controller and the pump settings.
	• Hydraulic system is closed or system pressure is insufficient.	Check the non-return valve and filter. Increase the system pressure.
7. Pump LED5 is on. Pump tries to restart every 1.5 sec.	• Rotor shaft is blocked.	Deblock the rotor shaft by pushing it with a screwdriver from the front of the pump.
8. Pump LED4 is on. Pump is running.	• Supply voltage is too low.	Check the supply voltage.
9. Pump LED3 is on. Pump stops.	• Supply voltage is too low.	• Check the supply voltage.
	• Serious failure.	• Exchange the pump.







FAULT	DISPLAY	SOLUTION
		
		
		
		

Fig. 71 Fault finding

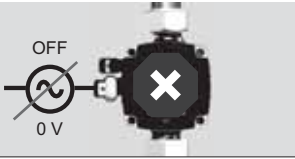
See video https://www.youtube.com/watch?v=cMC02526Z_s

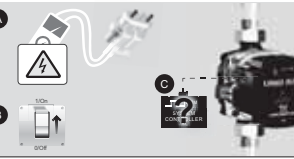
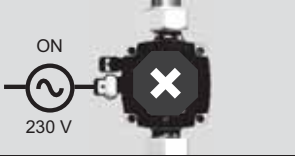
TM06 8448 0617

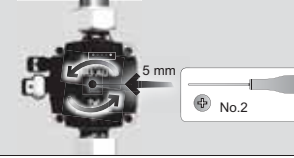
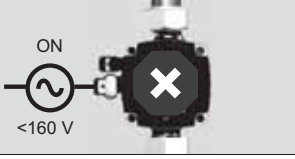
11. Disposing of the product

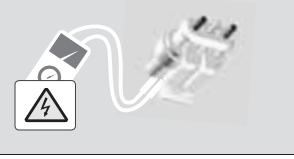
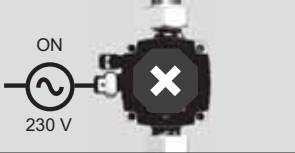
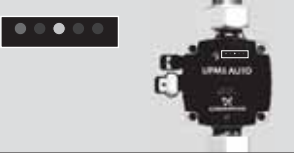
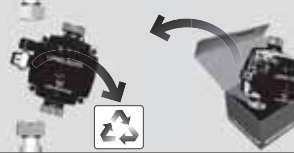

WARNING

Toxic material

- ▲ Death or serious personal injury
- ▶ Decontaminate pumps which handle fluids posing a health hazard.



Before dismantling the pump, drain the system, or close the isolating valves on either side of the pump.

This product or parts of it must be disposed of in an environmentally sound way:

- Use the public or private waste collection service.
- If this is not possible, contact the nearest Grundfos company or service workshop.

For information regarding materials used in the product and disassembly considerations, please see the product recycling section on the Grundfos website:

<http://www.grundfos.com/products/product-sustainability/product-recycling.html>

12. Control box positions

Different positions of the control box are available and must be defined as follows:

- IP44 versions without drain holes: All positions are allowed.
- IPX4D versions with drain holes (UPM3K, UPM3 SOLAR): The drain hole must point downwards after installation. Only connector positions to the side are possible.

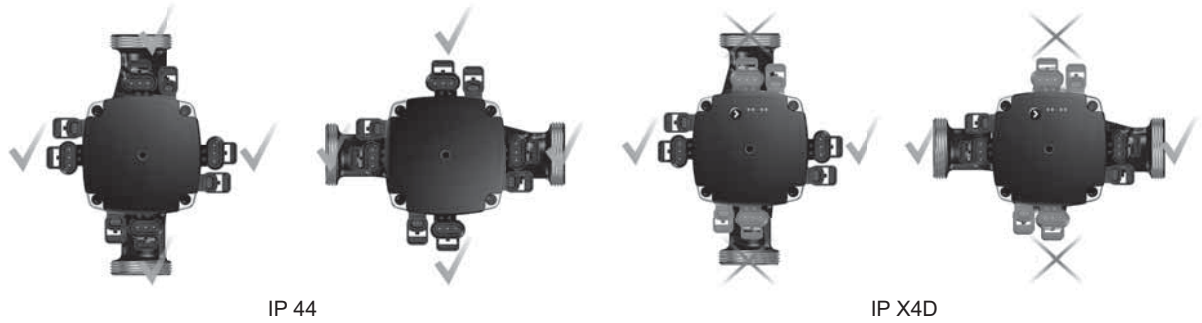

TM06 0855 1014

Name plate orientation after installation: horizontal				
Connector position	9 h	12 h	3 h	6 h
IP44 (without drain holes)	Allowed	Allowed	Allowed	Allowed
IPX4D (with drain hole downwards)	Allowed	Not allowed	Allowed	Not allowed

13. Performance curves and technical data

Curve conditions

The guidelines below apply to the performance curves on the following pages:

- Test liquid: airless water.
- The curves apply to a density of 998.21 kg/m³ and a liquid temperature of +20 °C.
- All curves show average values and should not be used as guarantee curves. If a specific minimum performance is required, individual measurements must be made.
- The curves apply to a kinematic viscosity of 1.004 mm²/s (1.004 cSt).
- The conversion between head H [m] and pressure p [kPa] has been made for water with a density of 1000 kg/m³. For liquids with other densities, e.g. hot water, the outlet pressure is proportional to the density.
- Curves obtained according to EN 16297.
- UPM3 with PWM signal connection are designed to be speed controlled by an external system controller. Therefore, EEI and P_{L,Avg} of the different pump heads (pumps without pump housings) are measured to be in compliance with the Ecodesign requirements of regulation EC/622/2012 with a reference housing in accordance with EN 16297-3.
- It is not obligatory to show P_{L,Avg} but it gives an indication on the yearly expectable average power consumption.
- The performance of PWM controlled pumps is measured with A profile (heating) at eight PWM values: 5 % (max.), 20 %, 31 %, 41 %, 52 %, 62 %, 73 %, 88 % (min.).
- C profile curves are measured mirrored with 95 % (max.), 80 %, 69 %, 59 %, 48 %, 38 %, 27 %, 12 % (min.).
- Maximum curves are limited by speed and power
- Variants with two different minimum curves are available: minimum curve A (standard) at approximately 0.1 m and minimum curve J (option) at approximately 1 m.
- Other curves for different control signals or OEM housings are available on request.

Measured pump head variants

Pump type	Product mark	P ₁ max. nom. [W]	Speed max. [min ⁻¹]	Speed min.	EEI Part 3	P _{L,Avg} [W]
UPM3(K) xx-75	GFNJC	60	5991	A (~ 0.1 m)	≤ 0.20	≤ 28
UPM3(K) xx-70	GFNJC	52	5766	A (~ 0.1 m)	≤ 0.20	≤ 23
UPM3(K) xx-60	GFNJC	39	5288	A (~ 0.1 m)	≤ 0.20	≤ 18
UPM3(K) xx-50	GFNJC	33	4838	A (~ 0.1 m)	≤ 0.20	≤ 16
UPM3(K) xx-40	GFNJC	25	4360	A (~ 0.1 m)	≤ 0.20	≤ 12
UPM3(K) FLEX AS xx-75	GFNJB	60	5991	A (~ 0.1 m)	≤ 0.20	≤ 28
UPM3(K) FLEX AS xx-70	GFNJB	52	5766	A (~ 0.1 m)	≤ 0.20	≤ 23
UPM3(K) FLEX AS xx-50	GFNJB	33	4838	A (~ 0.1 m)	≤ 0.20	≤ 16
UPM3(K) DHW xx-70	GFNJB	52	5766	A (~ 0.1 m)	≤ 0.20	≤ 23
UPM3(K) DHW xx-50	GFNJB	33	4848	A (~ 0.1 m)	≤ 0.20	≤ 16
UPM3(K) DHW xx-20	GFNJB	11	3122	A (~ 0.1 m)	≤ 0.20	≤ 7
UPM3(K) SOLAR xx-145	GFNJB	60	5794	A (~ 0.1 m)	≤ 0.20	≤ 25
UPM3(K) SOLAR xx-105	GFNJB	52	4950	A (~ 0.1 m)	≤ 0.20	≤ 22
UPM3(K) SOLAR xx-75	GFNJB	45	5991	A (~ 0.1 m)	≤ 0.20	≤ 20
UPM3(K) AUTO xx-70	GFNJB	52	5766	-	≤ 0.20	≤ 25
UPM3(K) AUTO xx-50	GFNJB	33	4838	-	≤ 0.20	≤ 16
UPM3(K) HYBRID xx-70	GFNJB	52	5766	A (~ 0.1 m)	≤ 0.20	≤ 25
UPM3(K) HYBRID xx-50	GFNJB	33	4838	A (~ 0.1 m)	≤ 0.20	≤ 16
UPM3L FLEX AS xx-75	GFNJG	75	5991	A (~ 0.1 m)	≤ 0.20	≤ 32
UPM3L xx-75	GFNJG	75	5991	A (~ 0.1 m)	≤ 0.20	≤ 32
UPM3S FLEX AS xx-60	GFNJD	42	5288	A (~ 0.1 m)	≤ 0.20	≤ 20
UPM3S xx-60	GFNJF	42	5288	A (~ 0.1 m)	≤ 0.20	≤ 20
UPM3S xx-50	GFNJF	34	4838	A (~ 0.1 m)	≤ 0.20	≤ 16
UPM3S xx-40	GFNJF	25	4360	A (~ 0.1 m)	≤ 0.20	≤ 12
UPMO xx-60	GFNJB	60	5766	J (~1 m)	≤ 0.20	≤ 25

14. Data sheets

UPM3(K) 15-75 130 (N), 25-75 130 (N), 25-75 180 (N), 32-75 180 (N) (GFNJC)

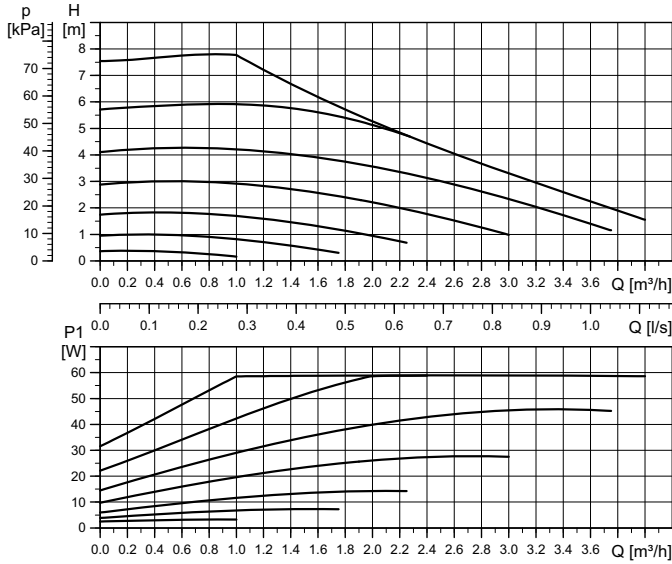

High efficiency

$E_{EEI} \leq 0.20$ Part 3
 $P_{L,avg} \leq 28$ W

Performance curve

Electrical data, 1 x 230 V, 50 Hz		
Speed	P_1 [W]	$I_{1/1}$ [A]
Min.	2	0.04
Max.	60	0.58

Settings
1 factory preset

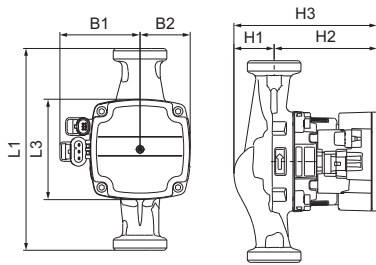

Dimensions

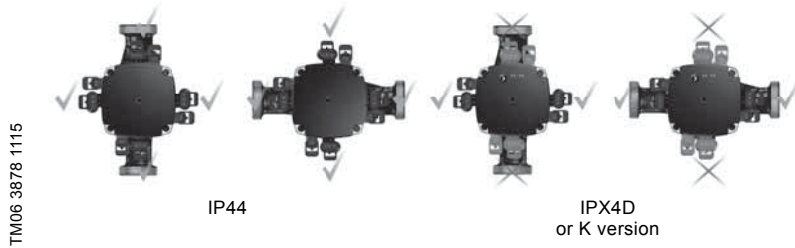

Control box position

Pump type	Dimensions [mm]							Connections [inch]	Weight [kg]
	L1	L3	B1	B2	H1	H2	H3		
UPM3(K) 15-75 130 (N)	130	90	72	45	36	92	128	R 1/2 / G 1	1.8
UPM3(K) 25-75 130 (N)	130	90	72	45	36	92	128	R 1 / G 1 1/2	1.9
UPM3(K) 25-75 180 (N)	180	90	72	45	36	92	128	R 1 / G 1 1/2	2.0
UPM3(K) 32-75 180 (N)	180	90	72	45	36	92	128	R 1 1/4 / G 2	2.0

Technical data

System pressure	Max. 1.0 MPa (10 bar)	Enclosure class	IP44 (non-condensing) K: IPX4D (condensing)
Minimum inlet pressure	0.05 MPa (0.50 bar) at 95 °C liquid temperature	Motor protection	No external protection needed
Liquid temperature	+2 °C to +110 °C (TF110)	Approval and marking	VDE, CE

TM06 0580 0814

TM06 3880 1115

UPM3(K) 15-70 130 (N), 25-70 130 (N), 25-70 180 (N), 32-70 180 (N) (GFNJC)

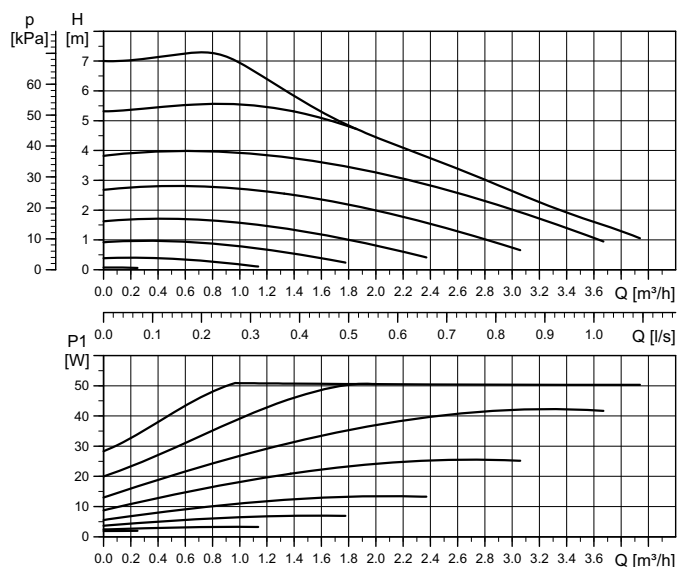

High efficiency

 $EEL \leq 0.20$ Part 3
 $P_{L,avg} \leq 23$ W

TM06 0579 0814

Performance curve

Electrical data, 1 x 230 V, 50 Hz		
Speed	P_1 [W]	$I_{1/1}$ [A]
Min.	2	0.04
Max.	52	0.52

Settings

1 factory preset

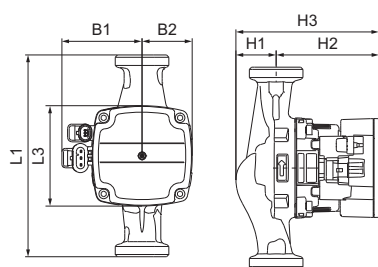

Dimensions

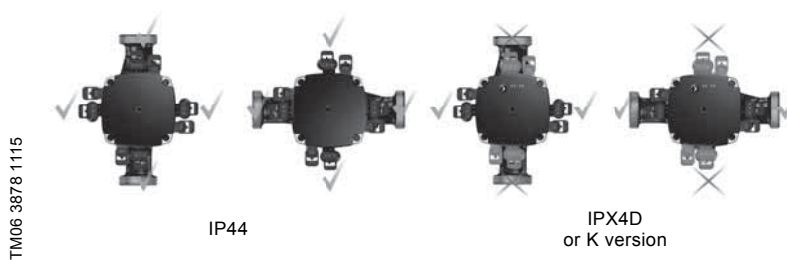

TM06 3878 1115

Control box position

IP44

IPX4D
or K version

TM06 3880 1115

Pump type	Dimensions [mm]							Connections [inch]	Weight [kg]
	L1	L3	B1	B2	H1	H2	H3		
UPM3(K) 15-70 130 (N)	130	90	72	45	36	92	128	R 1/2 / G 1	1.8
UPM3(K) 25-70 130 (N)	130	90	72	45	36	92	128	R 1 / G 1 1/2	1.9
UPM3(K) 25-70 180 (N)	180	90	72	45	36	92	128	R 1 / G 1 1/2	2.0
UPM3(K) 32-70 180 (N)	180	90	72	45	36	92	128	R 1 1/4 / G 2	2.2

Technical data

System pressure	Max. 1.0 MPa (10 bar)	Enclosure class	IP44 (non-condensing) K: IPX4D (condensing)
Minimum inlet pressure	0.05 MPa (0.50 bar) at 95 °C liquid temperature	Motor protection	No external protection needed
Liquid temperature	+2 °C to +110 °C (TF110)	Approval and marking	VDE, CE

UPM3(K) 15-60 130 (N), 25-60 130 (N), 25-60 180 (N), 32-60 180 (N) (GFNJC)

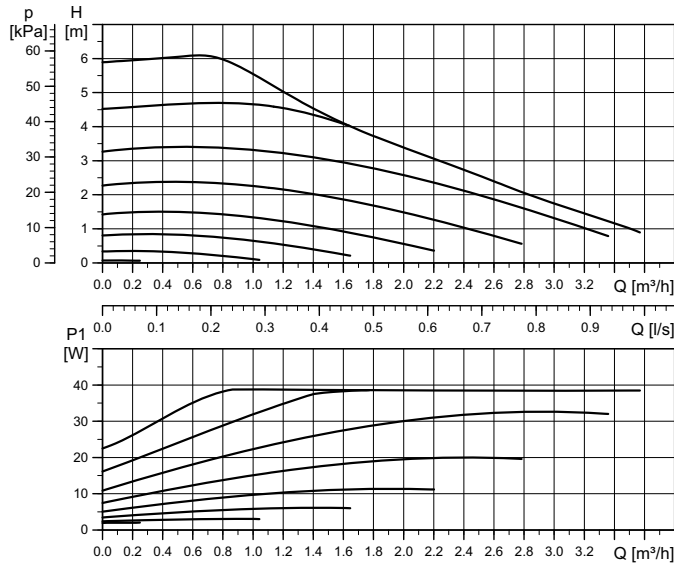

High efficiency

EEI ≤ 0.20 Part 3
P_{L,avg} ≤ 18 W

Performance curve

Electrical data, 1 x 230 V, 50 Hz		
Speed	P ₁ [W]	I _{1/1} [A]
Min.	2	0.04
Max.	39	0.42

Settings
1 factory preset

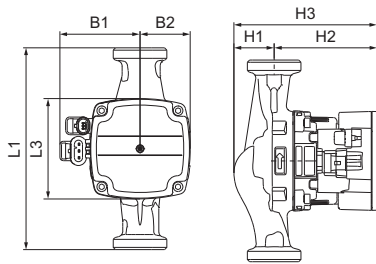

Dimensions

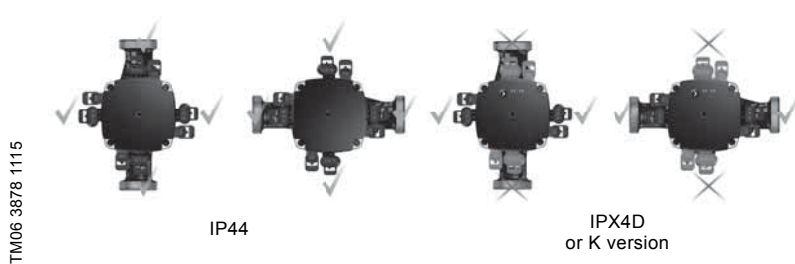

TM06 3878 1115

Control box position

TM06 3880 1115

Pump type	Dimensions [mm]							Connections [inch]	Weight [kg]
	L1	L3	B1	B2	H1	H2	H3		
UPM3(K) 15-60 130 (N)	130	90	72	45	36	92	128	R 1/2 / G 1	1.8
UPM3(K) 25-60 130 (N)	130	90	72	45	36	92	128	R 1 / G 1 1/2	1.9
UPM3(K) 25-60 180 (N)	180	90	72	45	36	92	128	R 1 / G 1 1/2	2.0
UPM3(K) 32-60 180 (N)	180	90	72	45	36	92	128	R 1 1/4 / G 2	2.2

Technical data

System pressure	Max. 1.0 MPa (10 bar)	Enclosure class	IP44 (non-condensing) K: IPX4D (condensing)
Minimum inlet pressure	0.05 MPa (0.50 bar) at 95 °C liquid temperature	Motor protection	No external protection needed
Liquid temperature	+2 °C to +110 °C (TF110)	Approval and marking	VDE, CE

UPM3(K) 15-50 130 (N), 25-50 130 (N), 25-50 180 (N), 32-50 180 (N) (GFNJC)

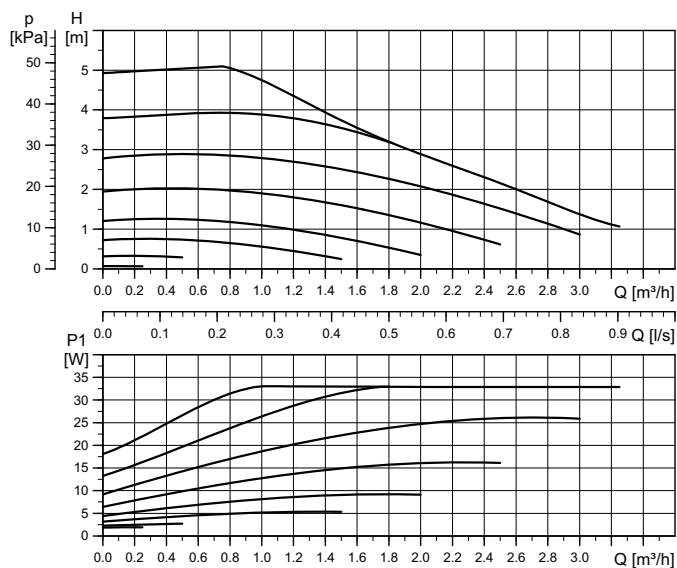

High efficiency

$EEl \leq 0.20$ Part 3
 $P_{L,avg} \leq 16$ W

TM06 0577 0814

Performance curve

Electrical data, 1 x 230 V, 50 Hz		
Speed	P_1 [W]	$I_{1/1}$ [A]
Min.	2	0.04
Max.	33	0.36

Settings
1 factory preset

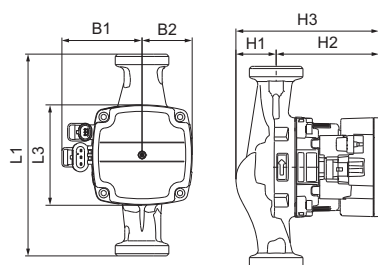

Dimensions

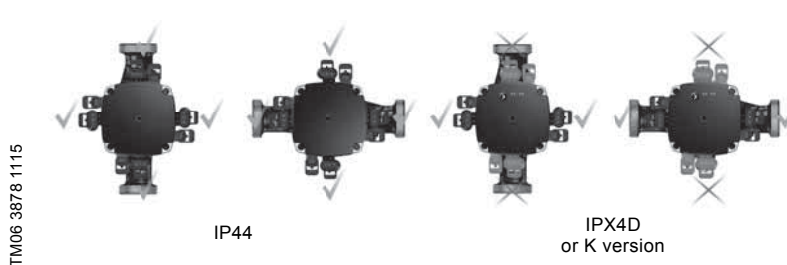

TM06 3878 1115

Control box position

TM06 3880 1115

Pump type	Dimensions [mm]							Connections [inch]	Weight [kg]
	L1	L3	B1	B2	H1	H2	H3		
UPM3(K) 15-50 130 (N)	130	90	72	45	36	92	128	R 1/2 / G 1	1.8
UPM3(K) 25-50 130 (N)	130	90	72	45	36	92	128	R 1 / G 1 1/2	1.9
UPM3(K) 25-50 180 (N)	180	90	72	45	36	92	128	R 1 / G 1 1/2	2.0
UPM3(K) 32-50 180 (N)	180	90	72	45	36	92	128	R 1 1/4 / G 2	2.2

Technical data

System pressure	Max. 1.0 MPa (10 bar)	Enclosure class	IP44 (non-condensing) K: IPX4D (condensing)
Minimum inlet pressure	0.05 MPa (0.50 bar) at 95 °C liquid temperature	Motor protection	No external protection needed
Liquid temperature	+2 °C to +110 °C (TF110)	Approval and marking	VDE, CE

UPM3(K) 15-40 130 (N), 25-40 130 (N), 25-40 180 (N), 32-40 180 (N) (GFNJC)

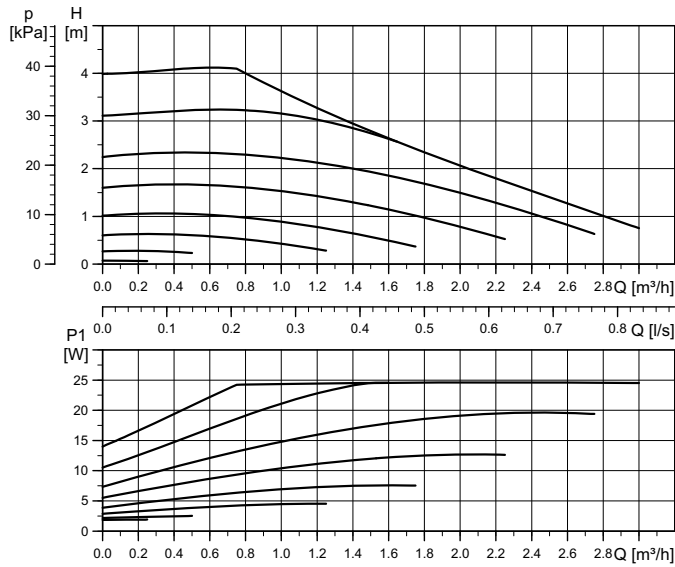

High efficiency

$E_{EEI} \leq 0.20$ Part 3
 $P_{L,avg} \leq 12$ W

Performance curve

Electrical data, 1 x 230 V, 50 Hz		
Speed	P ₁ [W]	I _{1/1} [A]
Min.	2	0.04
Max.	25	0.29

Settings
1 factory preset

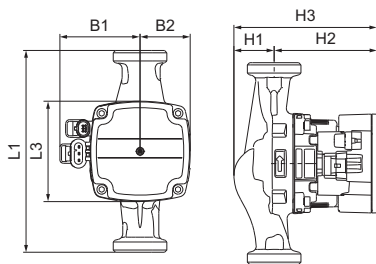

Dimensions

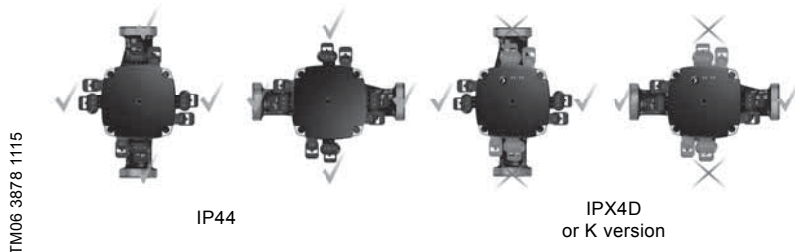

Control box position

Pump type	Dimensions [mm]							Connections [inch]	Weight [kg]
	L1	L3	B1	B2	H1	H2	H3		
UPM3(K) 15-40 130 (N)	130	90	72	45	36	92	128	R 1/2 / G 1	1.8
UPM3(K) 25-40 130 (N)	130	90	72	45	36	92	128	R 1 / G 1 1/2	1.9
UPM3(K) 25-40 180 (N)	180	90	72	45	36	92	128	R 1 / G 1 1/2	2.0
UPM3(K) 32-40 180 (N)	180	90	72	45	36	92	128	R 1 1/4 / G 2	2.2

Technical data

System pressure	Max. 1.0 MPa (10 bar)	Enclosure class	IP44 (non-condensing) K: IPX4D (condensing)
Minimum inlet pressure	0.05 MPa (0.50 bar) at 95 °C liquid temperature	Motor protection	No external protection needed
Liquid temperature	+2 °C to +110 °C (TF110)	Approval and marking	VDE, CE

TM06 3878 1115

TM06 3880 1115

UPM3(K) FLEX AS 15-75 130 (N), 25-75 130 (N), 25-75 180 (N), 32-75 180 (N) (GFNJB)

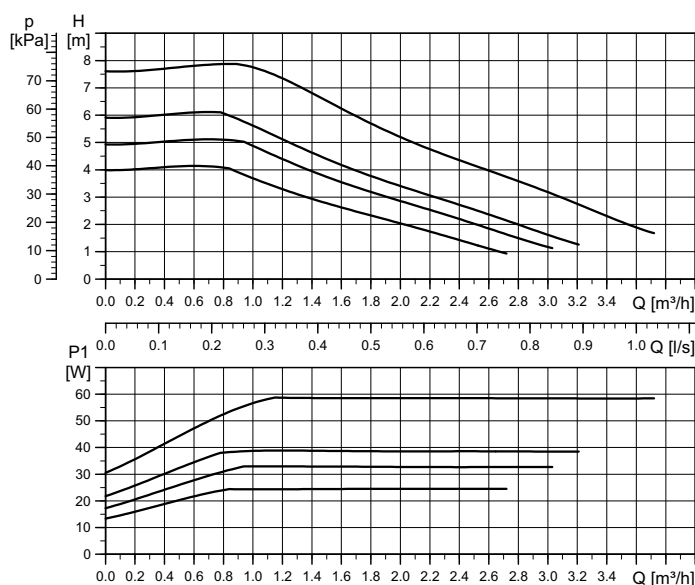

High efficiency

Setting	Max. head _{nom}
Curve 1	4 m
Curve 2	5 m
Curve 3	6 m
Curve 4	7.5 m

Setting	Max. P ₁ nom
Curve 1	25 W
Curve 2	33 W
Curve 3	39 W
Curve 4	60 W

EEL ≤ 0.20 Part 3
P_{L,avg} ≤ 28 W

TM06 3872 1115

Performance curve

Electrical data, 1 x 230 V, 50 Hz		
Speed	P ₁ [W]	I _{1/1} [A]
Min.	2	0.04
Max.	60	0.58

Settings				
PWM A	PWM C	PP	CP	CC
4	-	-	-	-

Note: For PWM speed curves see data sheet *UPM3(K) 15-75 130 (N), 25-75 130 (N), 25-75 180 (N), 32-75 180 (N) (GFNJC)*.

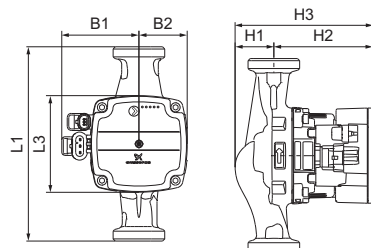

Dimensions

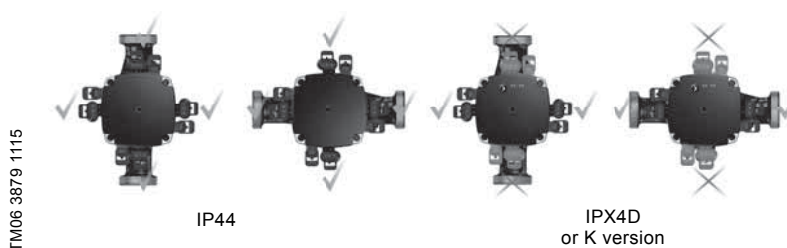

TM06 3879 1115

Control box position

TM06 3880 1115

Pump type	Dimensions [mm]							Connections [inch]	Weight [kg]
	L1	L3	B1	B2	H1	H2	H3		
UPM3(K) FLEX AS 15-75 130 (N)	130	90	72	45	36	92	128	R 1/2 / G 1	1.8
UPM3(K) FLEX AS 25-75 130 (N)	130	90	72	45	36	92	128	R 1 / G 1 1/2	1.9
UPM3(K) FLEX AS 25-75 180 (N)	180	90	72	45	36	92	128	R 1 / G 1 1/2	2.0
UPM3(K) FLEX AS 32-75 180 (N)	180	90	72	45	36	92	128	R 1 1/4 / G 2	2.0

Technical data

System pressure	Max. 1.0 MPa (10 bar)	Enclosure class	IP44 (non-condensing) K: IPX4D (condensing)
Minimum inlet pressure	0.05 MPa (0.50 bar) at 95 °C liquid temperature	Motor protection	No external protection needed
Liquid temperature	+2 °C to +110 °C (TF110)	Approval and marking	VDE, CE

UPM3(K) FLEX AS 15-70 130 (N), 25-70 130 (N), 25-70 180 (N), 32-70 180 (N) (GFNJB)

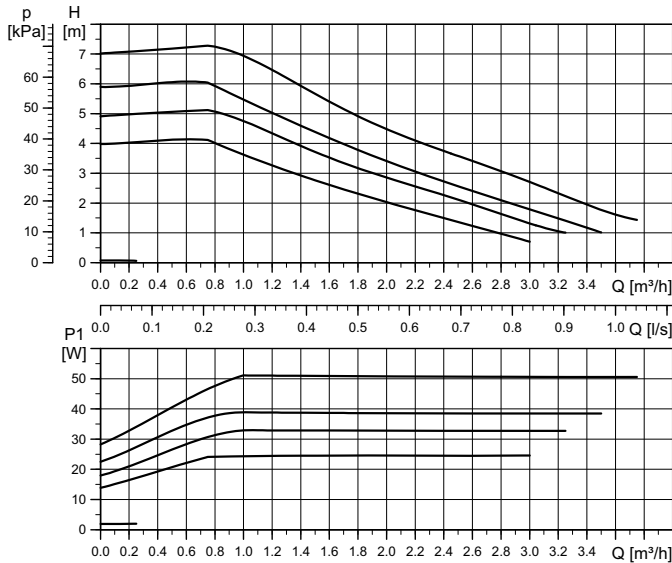

High efficiency

Setting	Max. head _{nom}
Curve 1	4 m
Curve 2	5 m
Curve 3	6 m
Curve 4	7 m

Setting	Max. P ₁ nom
Curve 1	25 W
Curve 2	33 W
Curve 3	39 W
Curve 4	52 W

EEl ≤ 0.20 Part 3
P_{L,avg} ≤ 23 W

TM06 0584 0814

Performance curve

Electrical data, 1 x 230 V, 50 Hz		
Speed	P ₁ [W]	I _{1/1} [A]
Min.	2	0.04
Max.	52	0.52

Settings				
PWM A	PWM C	PP	CP	CC
4	-	-	-	-

Note: For PWM speed curves see data sheet UPM3(K) 15-70 130 (N), 25-70 130 (N), 25-70 180 (N), 32-70 180 (N) (GFNJC).

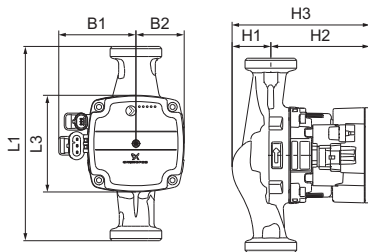

Dimensions

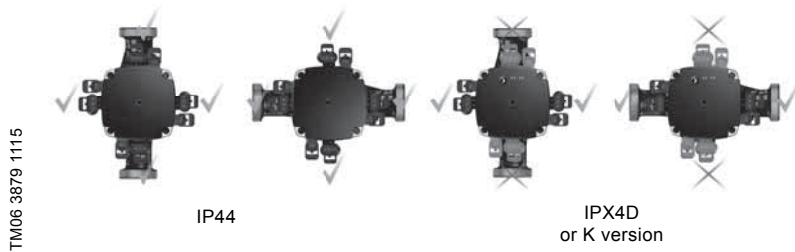

TM06 3879 1115

Control box position

TM06 3880 1115

Pump type	Dimensions [mm]							Connections [inch]	Weight [kg]
	L1	L3	B1	B2	H1	H2	H3		
UPM3(K) FLEX AS 15-70 130 (N)	130	90	72	45	36	92	128	R 1/2 / G 1	1.8
UPM3(K) FLEX AS 25-70 130 (N)	130	90	72	45	36	92	128	R 1 / G 1 1/2	1.9
UPM3(K) FLEX AS 25-70 180 (N)	180	90	72	45	36	92	128	R 1 / G 1 1/2	2.0
UPM3(K) FLEX AS 32-70 180 (N)	180	90	72	45	36	92	128	R 1 1/4 / G 2	2.2

Technical data

System pressure	Max. 1.0 MPa (10 bar)	Enclosure class	IP44 (non-condensing) K: IPX4D (condensing)
Minimum inlet pressure	0.05 MPa (0.50 bar) at 95 °C liquid temperature	Motor protection	No external protection needed
Liquid temperature	+2 °C to +110 °C (TF110)	Approval and marking	VDE, CE

UPM3(K) FLEX AS 15-50 130 (N), 25-50 130 (N), 25-50 180 (N), 32-50 180 (N) (GFNJB)

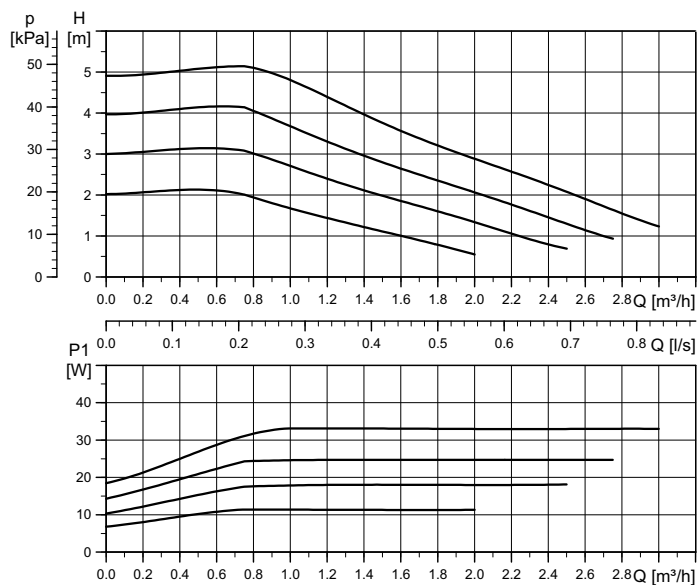

High efficiency

Setting	Max. head _{nom}
Curve 1	2 m
Curve 2	3 m
Curve 3	4 m
Curve 4	5 m

Setting	Max. P ₁ nom
Curve 1	11 W
Curve 2	18 W
Curve 3	25 W
Curve 4	33 W

EEI ≤ 0.20 Part 3
P_{L,avg} ≤ 16 W

TM06 4090 1515

Performance curve

Electrical data, 1 x 230 V, 50 Hz		
Speed	P ₁ [W]	I _{1/1} [A]
Min.	2	0.04
Max.	33	0.36

Settings				
PWM A	PWM C	PP	CP	CC
4	-	-	-	-

Note: For PWM speed curves see data sheet *UPM3(K) 15-50 130 (N), 25-50 130 (N), 25-50 180 (N), 32-50 180 (N) (GFNJC)*.

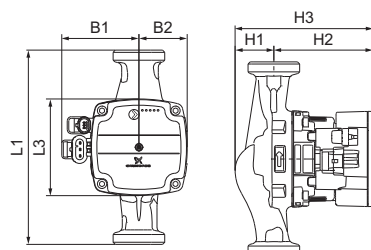

Dimensions

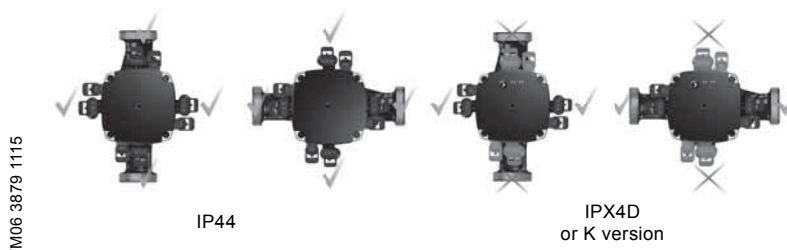

TM06 3879 1115

Control box position

TM06 3880 1115

Pump type	Dimensions [mm]							Connections [inch]	Weight [kg]
	L1	L3	B1	B2	H1	H2	H3		
UPM3(K) FLEX AS 15-50 130 (N)	130	90	72	45	36	92	128	R 1/2 / G 1	1.8
UPM3(K) FLEX AS 25-50 130 (N)	130	90	72	45	36	92	128	R 1 / G 1 1/2	1.9
UPM3(K) FLEX AS 25-50 180 (N)	180	90	72	45	36	92	128	R 1 / G 1 1/2	2.0
UPM3(K) FLEX AS 32-50 180 (N)	180	90	72	45	36	92	128	R 1 1/4 / G 2	2.2

Technical data

System pressure	Max. 1.0 MPa (10 bar)	Enclosure class	IP44 (non-condensing) K: IPX4D (condensing)
Minimum inlet pressure	0.05 MPa (0.50 bar) at 95 °C liquid temperature	Motor protection	No external protection needed
Liquid temperature	+2 °C to +110 °C (TF110)	Approval and marking	VDE, CE

UPM3(K) AUTO 15-70 130 (N), 25-70 130 (N), 25-70 180 (N), 32-70 180 (N) (GFNJB)

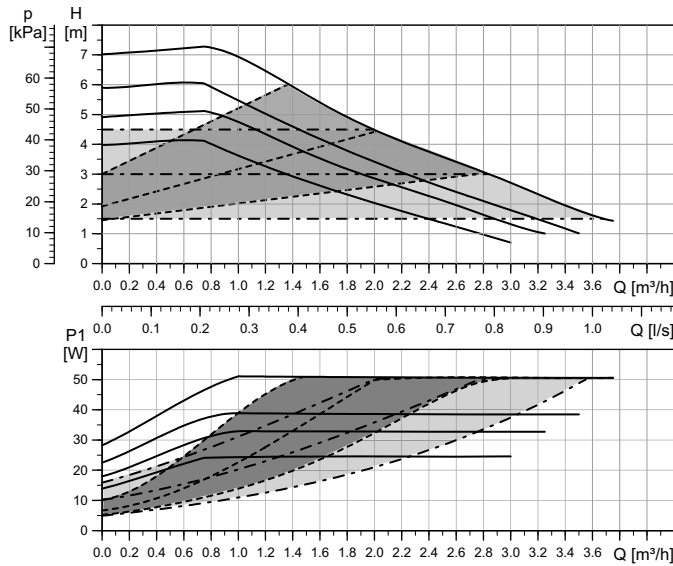

High efficiency

Setting	Max. head _{nom}
Curve 1	4 m
Curve 2	5 m
Curve 3	6 m
Curve 4	7 m

Setting	Max. P _{1 nom}
Curve 1	25 W
Curve 2	33 W
Curve 3	39 W
Curve 4	52 W

EEl ≤ 0.20 Part 3
P_{L,avg} ≤ 25 W

Performance curve

Line type	Description
—	Constant Curve
- - - - -	Proportional Pressure
- - - - -	Constant Pressure

Electrical data, 1 x 230 V, 50 Hz		
Speed	P ₁ [W]	I _{1/1} [A]
Min.	5	0.07
Max.	52	0.52

Settings				
PWM A	PWM C	PP	CP	CC
-	-	3/AA	3/AA	4

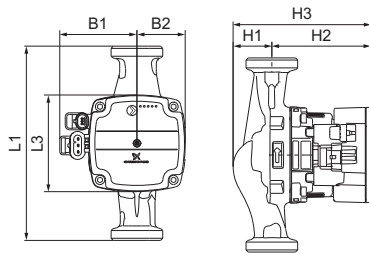

Dimensions

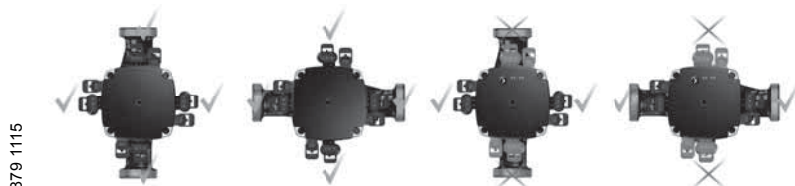

TM06 3879 1115

IP44

IPX4D or K version

TM06 3880 1115

Control box position

Pump type	Dimensions [mm]							Connections [inch]	Weight [kg]
	L1	L3	B1	B2	H1	H2	H3		
UPM3(K) AUTO 15-70 130 (N)	130	90	72	45	36	92	128	R 1/2 / G 1	1.8
UPM3(K) AUTO 25-70 130 (N)	130	90	72	45	36	92	128	R 1 / G 1 1/2	1.9
UPM3(K) AUTO 25-70 180 (N)	180	90	72	45	36	92	128	R 1 / G 1 1/2	2.0
UPM3(K) AUTO 32-70 180 (N)	180	90	72	45	36	92	128	R 1 1/4 / G 2	2.2

Technical data

System pressure	Max. 1.0 MPa (10 bar)	Enclosure class	IP44 (non-condensing) K: IPX4D (condensing)
Minimum inlet pressure	0.05 MPa (0.50 bar) at 95 °C liquid temperature	Motor protection	No external protection needed
Liquid temperature	+2 °C to +110 °C (TF110)	Approval and marking	VDE, CE

UPM3(K) AUTO 15-50 130 (N), 25-50 130 (N), 25-50 180 (N), 32-50 180 (N) (GFNJB)

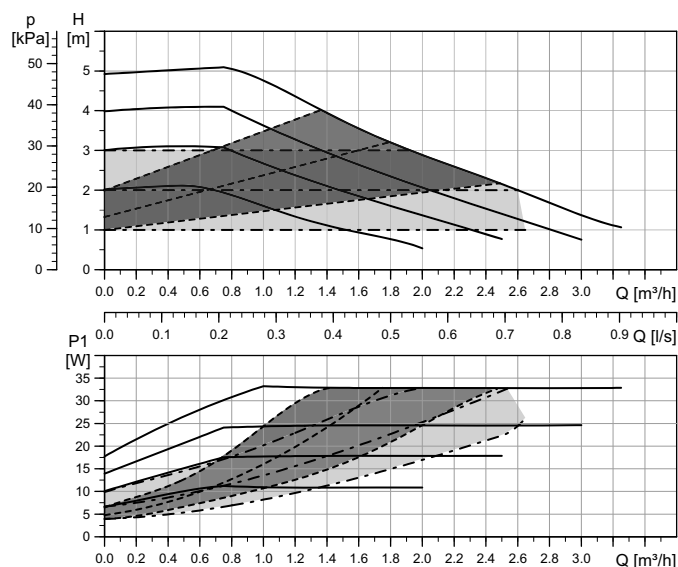

High efficiency

Setting	Max. head _{nom}
Curve 1	2 m
Curve 2	3 m
Curve 3	4 m
Curve 4	5 m

Setting	Max. P _{1 nom}
Curve 1	11 W
Curve 2	18 W
Curve 3	25 W
Curve 4	33 W

EEL ≤ 0.20 Part 3
P_{L,avg} ≤ 16 W

TM06 1180 1814

Performance curve

Line type	Description
—————	Constant Curve
-----	Proportional Pressure
- - - - -	Constant Pressure

Electrical data, 1 x 230 V, 50 Hz

Speed	P ₁ [W]	I _{1/1} [A]
Min.	4	0.06
Max.	33	0.36

Settings

PWM A	PWM C	PP	CP	CC
-	-	3/AA	3/AA	4

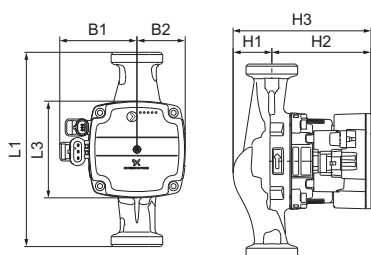

Dimensions

TM06 3879 1115

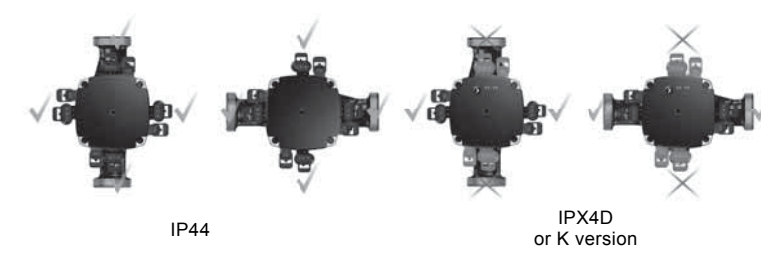

Control box position

TM06 3880 1115

Pump type	Dimensions [mm]							Connections [inch]	Weight [kg]
	L1	L3	B1	B2	H1	H2	H3		
UPM3(K) AUTO 15-50 130 (N)	130	90	72	45	36	92	128	R 1/2 / G 1	1.8
UPM3(K) AUTO 25-50 130 (N)	130	90	72	45	36	92	128	R 1 / G 1 1/2	1.9
UPM3(K) AUTO 25-50 180 (N)	180	90	72	45	36	92	128	R 1 / G 1 1/2	2.0
UPM3(K) AUTO 32-50 180 (N)	180	90	72	45	36	92	128	R 1 1/4 / G 2	2.2

Technical data

System pressure	Max. 1.0 MPa (10 bar)	Enclosure class	IP44 (non-condensing) K: IPX4D (condensing)
Minimum inlet pressure	0.05 MPa (0.50 bar) at 95 °C liquid temperature	Motor protection	No external protection needed
Liquid temperature	+2 °C to +110 °C (TF110)	Approval and marking	VDE, CE

UPM3(K) HYBRID 15-70 130 (N), 25-70 130 (N), 25-70 180 (N), 32-70 180 (N) (GFNJJB)

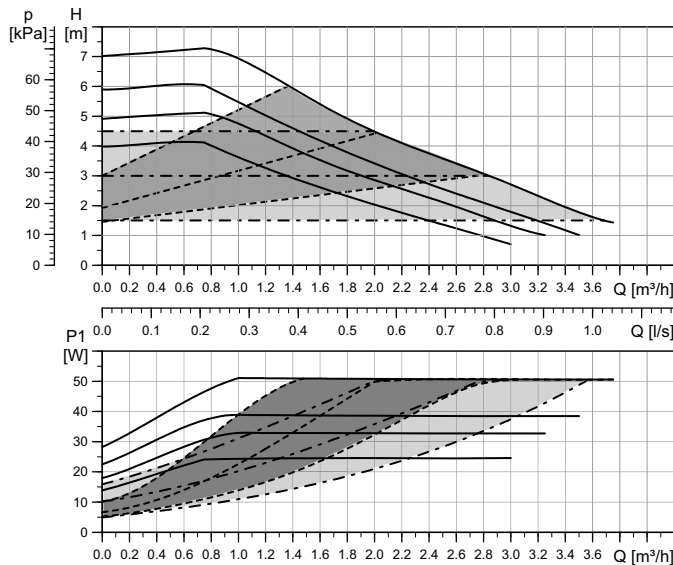

High efficiency

Setting	Max. head _{nom}
Curve 1	4 m
Curve 2	5 m
Curve 3	6 m
Curve 4	7 m

Setting	Max. P _{1 nom}
Curve 1	25 W
Curve 2	33 W
Curve 3	39 W
Curve 4	52 W

EEL ≤ 0.20 Part 3
P_{L,avg} ≤ 25 W

TM06 1179 1814

Performance curve

Line type	Description
—————	Constant Curve
-----	Proportional Pressure
- - - - -	Constant Pressure

Electrical data, 1 x 230 V, 50 Hz		
Speed	P ₁ [W]	I _{1/1} [A]
Min.	2	0.04
Max.	52	0.52

Settings				
PWM A	PWM C	PP	CP	CC
4	4	3/AA	3/AA	4

Note: For PWM speed curves see data sheet UPM3(K) 15-70 130 (N), 25-70 130 (N), 25-70 180 (N), 32-70 180 (N) (GFNJJC).

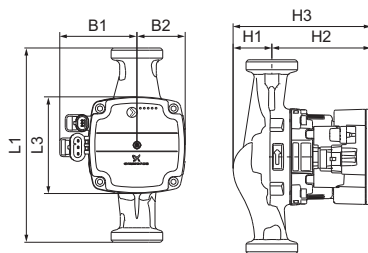

Dimensions

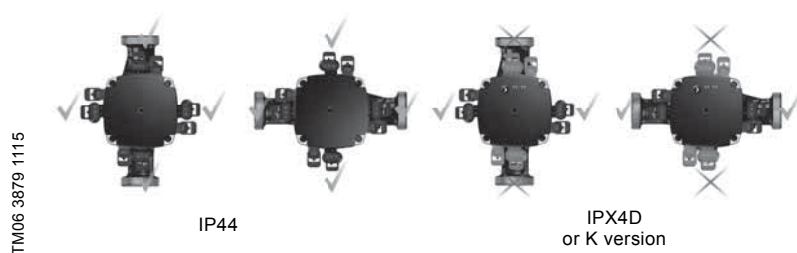

TM06 3879 1115

IP44

IPX4D
or K version

TM06 3880 1115

Control box position

Pump type	Dimensions [mm]							Connections [inch]	Weight [kg]
	L1	L3	B1	B2	H1	H2	H3		
UPM3(K) HYBRID 15-70 130 (N)	130	90	72	45	36	92	128	R 1/2 / G 1	1.8
UPM3(K) HYBRID 25-70 130 (N)	130	90	72	45	36	92	128	R 1 / G 1 1/2	1.9
UPM3(K) HYBRID 25-70 180 (N)	180	90	72	45	36	92	128	R 1 / G 1 1/2	2.0
UPM3(K) HYBRID 32-70 180 (N)	180	90	72	45	36	92	128	R 1 1/4 / G 2	2.2

Technical data

System pressure	Max. 1.0 MPa (10 bar)	Enclosure class	IP44 (non-condensing) K: IPX4D (condensing)
Minimum inlet pressure	0.05 MPa (0.50 bar) at 95 °C liquid temperature	Motor protection	No external protection needed
Liquid temperature	+2 °C to +110 °C (TF110)	Approval and marking	VDE, CE

UPM3(K) HYBRID 15-50 130 (N), 25-50 130 (N), 25-50 180 (N), 32-50 180 (N) (GFNJJB)

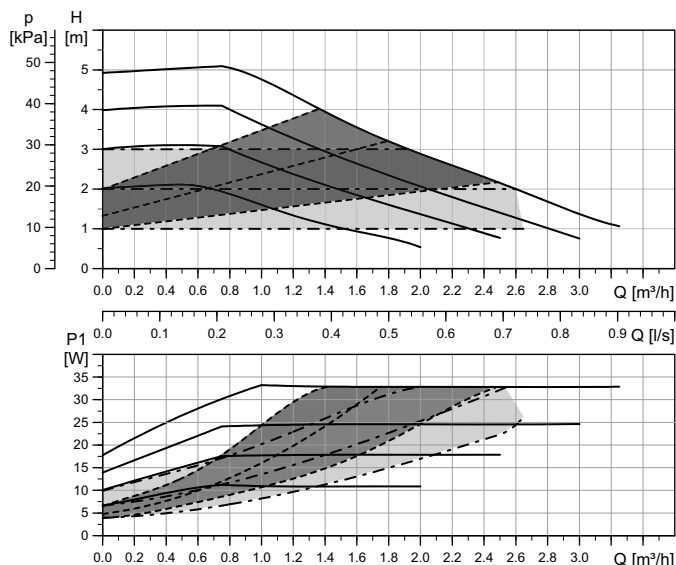

High efficiency

Setting	Max. head nom
Curve 1	2 m
Curve 2	3 m
Curve 3	4 m
Curve 4	5 m

Setting	Max. P_1 nom
Curve 1	11 W
Curve 2	18 W
Curve 3	25 W
Curve 4	33 W

EEI \leq 0.20 Part 3
 $P_{L,avg} \leq$ 16 W

TM06 1180 1814

Performance curve

Line type	Description
—————	Constant Curve
-----	Proportional Pressure
- - - - -	Constant Pressure

Electrical data, 1 x 230 V, 50 Hz		
Speed	P_1 [W]	$I_{1/1}$ [A]
Min.	2	0.04
Max.	33	0.36

Settings				
PWM A	PWM C	PP	CP	CC
4	4	3/AA	3/AA	4

Note: For PWM speed curves see data sheet UPM3(K) 15-50 130 (N), 25-50 130 (N), 25-50 180 (N), 32-50 180 (N) (GFNJJC).

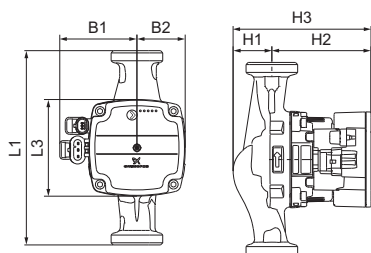

Dimensions

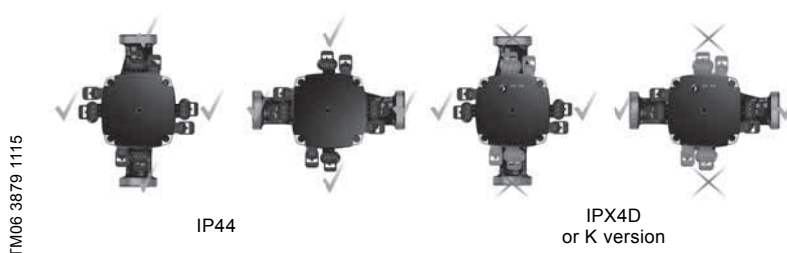

TM06 3879 1115

Control box position

TM06 3880 1115

Pump type	Dimensions [mm]							Connections [inch]	Weight [kg]
	L1	L3	B1	B2	H1	H2	H3		
UPM3(K) HYBRID 15-50 130 (N)	130	90	72	45	36	92	128	R 1/2 / G 1	1.8
UPM3(K) HYBRID 25-50 130 (N)	130	90	72	45	36	92	128	R 1 / G 1 1/2	1.9
UPM3(K) HYBRID 25-50 180 (N)	180	90	72	45	36	92	128	R 1 / G 1 1/2	2.0
UPM3(K) HYBRID 32-50 180 (N)	180	90	72	45	36	92	128	R 1 1/4 / G 2	2.2

Technical data

System pressure	Max. 1.0 MPa (10 bar)	Enclosure class	IP44 (non-condensing) K: IPX4D (condensing)
Minimum inlet pressure	0.05 MPa (0.50 bar) at 95 °C liquid temperature	Motor protection	No external protection needed
Liquid temperature	+2 °C to +110 °C (TF110)	Approval and marking	VDE, CE

UPM3(K) DHW 25-70 130 N, 25-70 180 N, 32-70 180 N (GFNJB)

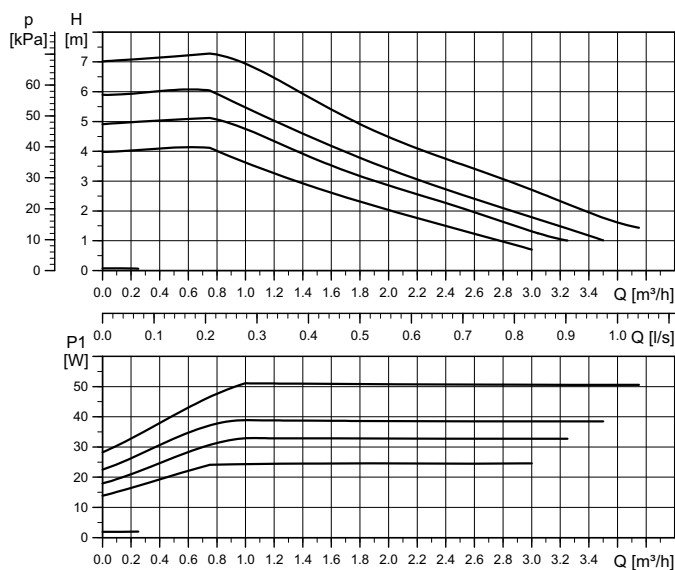

High efficiency

Setting	Max. head _{nom}
Curve 1	4 m
Curve 2	5 m
Curve 3	6 m
Curve 4	7 m

Setting	Max. P ₁ nom
Curve 1	25 W
Curve 2	33 W
Curve 3	39 W
Curve 4	52 W

EEI ≤ 0.20 Part 3
P_{L,avg} ≤ 23 W

TM06 0584 0814

Performance curve

Electrical data, 1 x 230 V, 50 Hz		
Speed	P ₁ [W]	I _{1/1} [A]
Min.	2	0.04
Max.	52	0.52

Settings				
PWM A	PWM C	PP	CP	CC
4	-	-	-	-

Note: For PWM speed curves see data sheet *UPM3(K) 15-70 130 (N), 25-70 130 (N), 25-70 180 (N), 32-70 180 (N) (GFNJC)*.

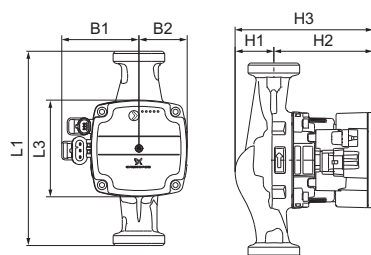

Dimensions

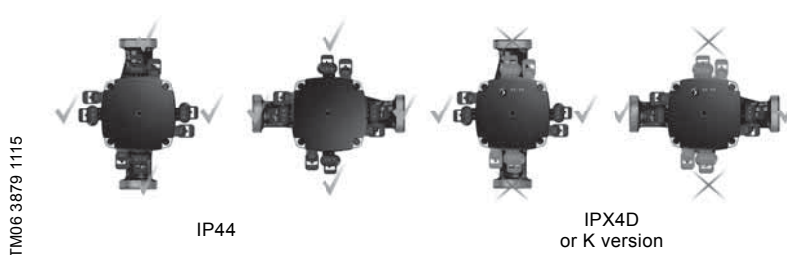

TM06 3879 1115

Control box position

TM06 3880 1115

Pump type	Dimensions [mm]							Connections [inch]	Weight [kg]
	L1	L3	B1	B2	H1	H2	H3		
UPM3(K) DHW 25-70 130 N	130	90	72	45	36	92	128	R 1 / G 1 1/2	2.1
UPM3(K) DHW 25-70 180 N	180	90	72	45	36	92	128	R 1 / G 1 1/2	2.2
UPM3(K) DHW 32-70 180 N	180	90	72	45	36	92	128	R 1 1/4 / G 2	2.4

Technical data

System pressure	Max. 1.0 MPa (10 bar)	Enclosure class	IP44 (non-condensing) K: IPX4D (condensing)
Minimum inlet pressure	0.05 MPa (0.50 bar) at 95 °C liquid temperature	Motor protection	No external protection needed
Liquid temperature	+2 °C to +110 °C (TF110)	Approval and marking	VDE, CE, drinking water approvals KTW (DE), DVGW W270 (DE), ACS (FR), WRAS (GB)
Temporary hardness	Max. 3 mmol/l CaCO ₃ (16.8 °dH)		

UPM3(K) DHW 25-50 130 N, 25-50 180 N, 32-50 180 N (GFNJB)

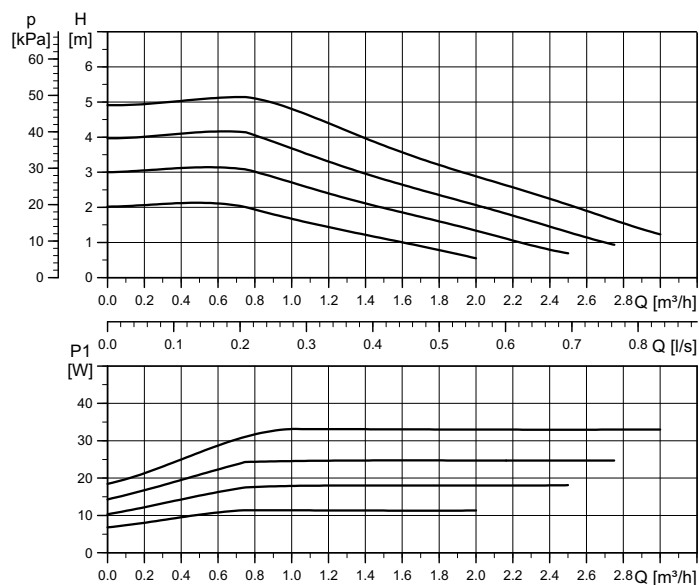

High efficiency

Setting	Max. head _{nom}
Curve 1	2 m
Curve 2	3 m
Curve 3	4 m
Curve 4	5 m

Setting	Max. P ₁ nom
Curve 1	11 W
Curve 2	18 W
Curve 3	25 W
Curve 4	33 W

EEl ≤ 0.20 Part 3
P_{L,avg} ≤ 16 W

TM06 4074 1515

Performance curve

Electrical data, 1 x 230 V, 50 Hz		
Speed	P ₁ [W]	I _{1/1} [A]
Min.	2	0.04
Max.	33	0.36

Settings				
PWM A	PWM C	PP	CP	CC
4	-	-	-	-

Note: For PWM speed curves see data sheet *UPM3(K) 15-50 130 (N), 25-50 130 (N), 25-50 180 (N), 32-50 180 (N) (GFNJC)*.

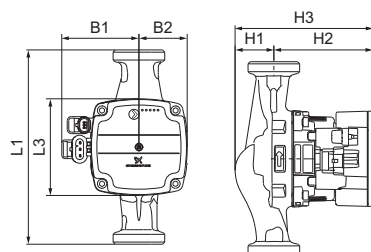

Dimensions

TM06 3879 1115

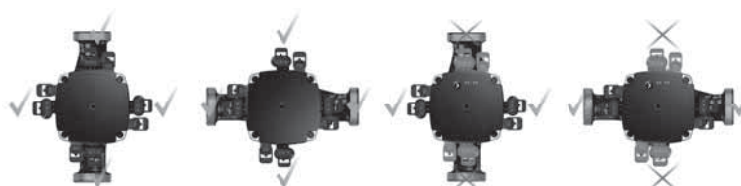

IP44

IPX4D
or K version

TM06 3880 1115

Control box position

Pump type	Dimensions [mm]							Connections [inch]	Weight [kg]
	L1	L3	B1	B2	H1	H2	H3		
UPM3(K) DHW 25-50 130 N	130	90	72	45	36	92	128	R 1 / G 1 1/2	2.1
UPM3(K) DHW 25-50 180 N	180	90	72	45	36	92	128	R 1 / G 1 1/2	2.2
UPM3(K) DHW 32-50 180 N	180	90	72	45	36	92	128	R 1 1/4 / G 2	2.4

Technical data

System pressure	Max. 1.0 MPa (10 bar)	Enclosure class	IP44 (non-condensing) K: IPX4D (condensing)
Minimum inlet pressure	0.05 MPa (0.50 bar) at 95 °C liquid temperature	Motor protection	No external protection needed
Liquid temperature	+2 °C to +110 °C (TF110)	Approval and marking	VDE, CE, drinking water approvals KTW (DE), DVGW W270 (DE), ACS (FR), WRAS (GB)
Temporary hardness	Max. 3 mmol/l CaCO ₃ (16.8 °dH)		

UPM3(K) DHW 25-20 130 N, 25-20 180 N, 32-20 180 N (GFNJB)

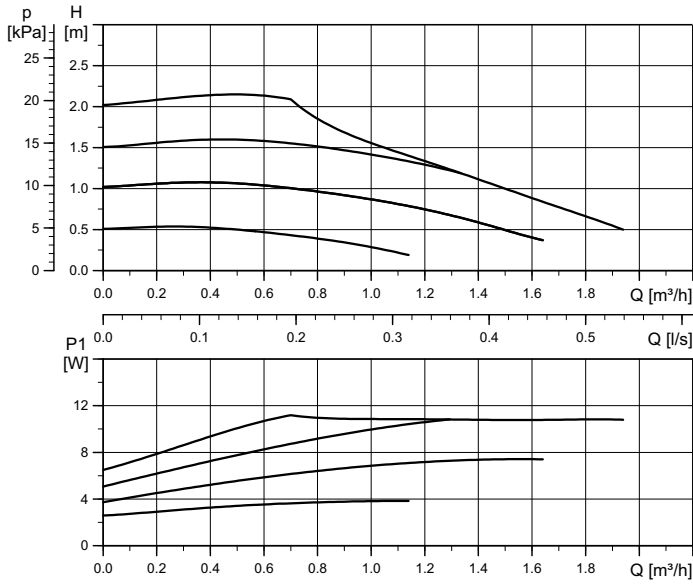

High efficiency

Setting	Max. head _{nom}
Curve 1	0.5 m
Curve 2	1 m
Curve 3	1.5 m
Curve 4	2 m

Setting	Max. P ₁ nom
Curve 1	4 W
Curve 2	7 W
Curve 3	9 W
Curve 4	11 W

EEI ≤ 0.20 Part 3
P_{L,avg} ≤ 7 W

TM06 4075 1515

Performance curve

Electrical data, 1 x 230 V, 50 Hz		
Speed	P ₁ [W]	I _{1/1} [A]
Min.	2	0.04
Max.	12	0.14

Settings				
PWM A	PWM C	PP	CP	CC
4	-	-	-	-

Note: PWM speed curves on request.

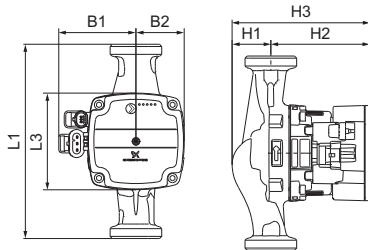

Dimensions

TM06 3879 1115

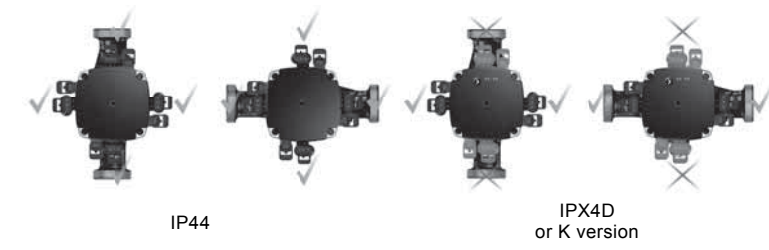

Control box position

TM06 3880 1115

Pump type	Dimensions [mm]							Connections [inch]	Weight [kg]
	L1	L3	B1	B2	H1	H2	H3		
UPM3(K) DHW 25-20 130 N	130	90	72	45	36	92	128	R 1 / G 1 1/2	2.1
UPM3(K) DHW 25-20 180 N	180	90	72	45	36	92	128	R 1 / G 1 1/2	2.2
UPM3(K) DHW 32-20 180 N	180	90	72	45	36	92	128	R 1 1/4 / G 2	2.4

Technical data

System pressure	Max. 1.0 MPa (10 bar)	Enclosure class	IP44 (non-condensing) K: IPX4D (condensing)
Minimum inlet pressure	0.05 MPa (0.50 bar) at 95 °C liquid temperature	Motor protection	No external protection needed
Liquid temperature	+2 °C to +110 °C (TF110)	Approval and marking	VDE, CE, drinking water approvals KTW (DE), DVGW W270 (DE), ACS (FR), WRAS (GB)
Temporary hardness	Max. 3 mmol/l CaCO ₃ (16.8 °dH)		

UPM3(K) DHW 15-70 CIL3 PPS (GFNJJB)

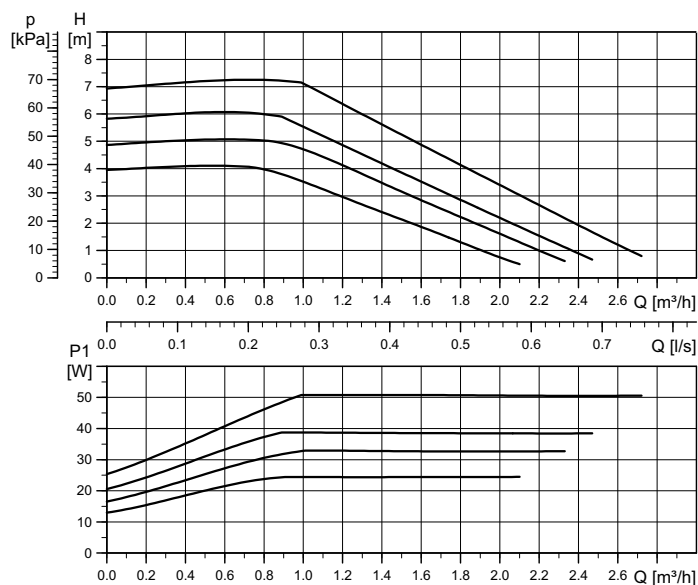

High efficiency

Setting	Max. head _{nom}
Curve 1	4 m
Curve 2	5 m
Curve 3	6 m
Curve 4	7 m

Setting	Max. P ₁ nom
Curve 1	25 W
Curve 2	33 W
Curve 3	39 W
Curve 4	52 W

EEl ≤ 0.20 Part 3
P_{L,avg} ≤ 23 W

TM06 4076 1515

Performance curve

Electrical data, 1 x 230 V, 50 Hz		
Speed	P ₁ [W]	I _{1/1} [A]
Min.	2	0.04
Max.	52	0.52

Settings				
PWM A	PWM C	PP	CP	CC
4	-	-	-	-

Note: PWM speed curves on request.

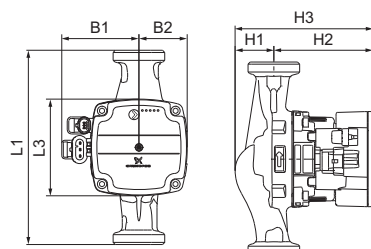

Dimensions

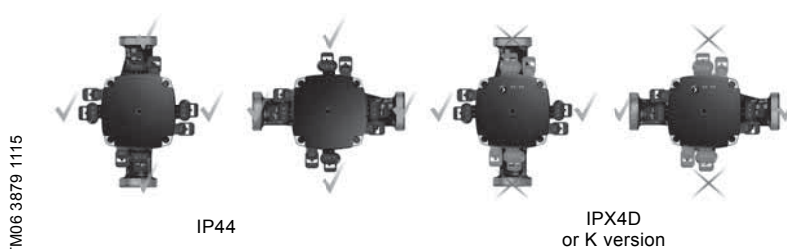

Control box position

Pump type	Dimensions [mm]							Connections [inch]	Weight [kg]
	L1	L3	B1	B2	H1	H2	H3		
UPM3(K) DHW 15-70 CIL3 PPS	130	90	72	45	36	92	128	R 1/2 / G 1	1.3

Technical data

System pressure	Max. 1.0 MPa (10 bar)	Enclosure class	IP44 (non-condensing) K: IPX4D (condensing)
Minimum inlet pressure	0.05 MPa (0.50 bar) at 95 °C liquid temperature	Motor protection	No external protection needed
Liquid temperature	+2 °C to +95 °C (TF95)	Approval and marking	VDE, CE, drinking water approvals KTW (DE), DVGW W270 (DE), ACS (FR), WRAS (GB)
Temporary hardness	Max. 3 mmol/l CaCO ₃ (16.8 °dH)		

UPM3(K) DHW 15-50 CIL3 PPS (GFNJJB)

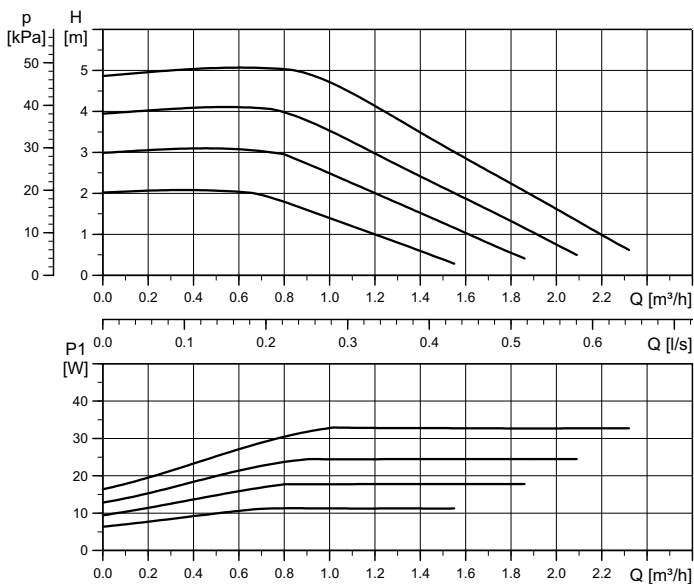

High efficiency

Setting	Max. head _{nom}
Curve 1	2 m
Curve 2	3 m
Curve 3	4 m
Curve 4	5 m

Setting	Max. P ₁ nom
Curve 1	11 W
Curve 2	18 W
Curve 3	25 W
Curve 4	33 W

EEl ≤ 0.20 Part 3
P_{L,avg} ≤ 16 W

TM06 4077 1515

Performance curve

Electrical data, 1 x 230 V, 50 Hz		
Speed	P ₁ [W]	I _{1/1} [A]
Min.	2	0.04
Max.	33	0.34

Settings				
PWM A	PWM C	PP	CP	CC
4	-	-	-	-

Note: PWM speed curves on request.

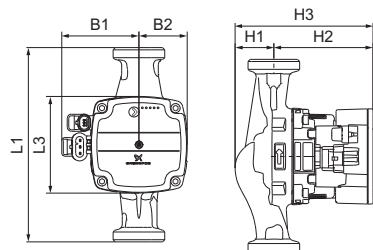

Dimensions

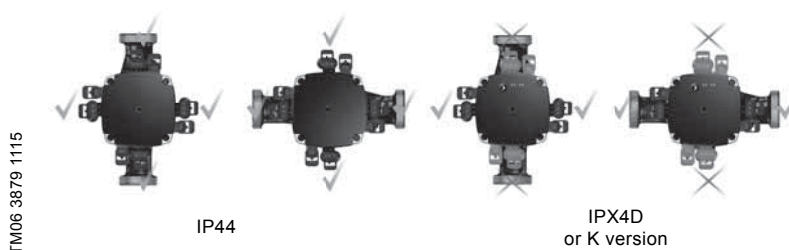

Control box position

Pump type	Dimensions [mm]							Connections [inch]	Weight [kg]
	L1	L3	B1	B2	H1	H2	H3		
UPM3(K) DHW 15-50 CIL3 PPS	130	90	72	45	36	92	128	R 1/2 / G 1	1.3

Technical data

System pressure	Max. 1.0 MPa (10 bar)	Enclosure class	IP44 (non-condensing) K: IPX4D (condensing)
Minimum inlet pressure	0.05 MPa (0.50 bar) at 95 °C liquid temperature	Motor protection	No external protection needed
Liquid temperature	+2 °C to +95 °C (TF95)	Approval and marking	VDE, CE, drinking water approvals KTW (DE), DVGW W270 (DE), ACS (FR), WRAS (GB)
Temporary hardness	Max. 3 mmol/l CaCO ₃ (16.8 °dH)		

UPM3(K) DHW 15-20 CIL3 PPS (GFNJB)

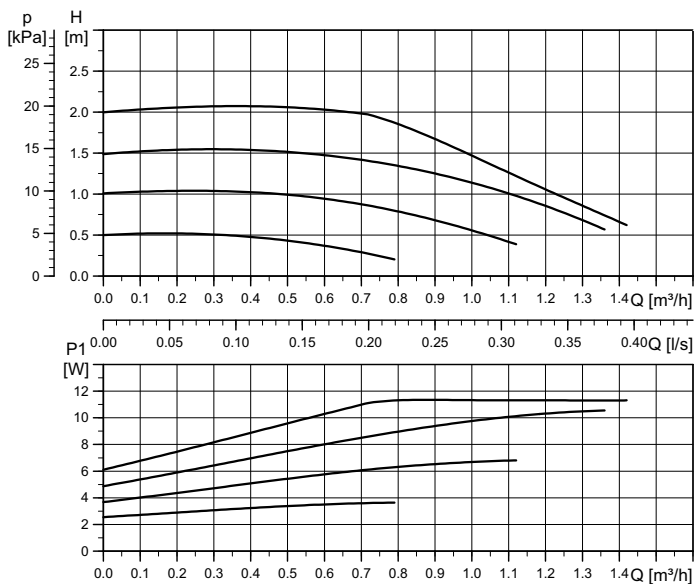

High efficiency

Setting	Max. head _{nom}
Curve 1	0.5 m
Curve 2	1 m
Curve 3	1.5 m
Curve 4	2 m

Setting	Max. P ₁ nom
Curve 1	4 W
Curve 2	7 W
Curve 3	9 W
Curve 4	11 W

EEl ≤ 0.20 Part 3
P_{L,avg} ≤ 7 W

TM06 4078 1515

Performance curve

Electrical data, 1 x 230 V, 50 Hz		
Speed	P ₁ [W]	I _{1/1} [A]
Min.	2	0.04
Max.	12	0.14

Settings				
PWM A	PWM C	PP	CP	CC
4	-	-	-	-

Note: PWM speed curves on request.

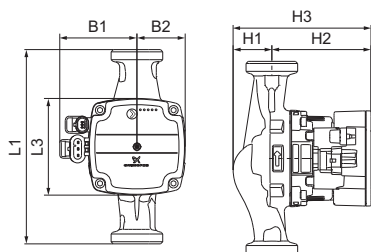

Dimensions

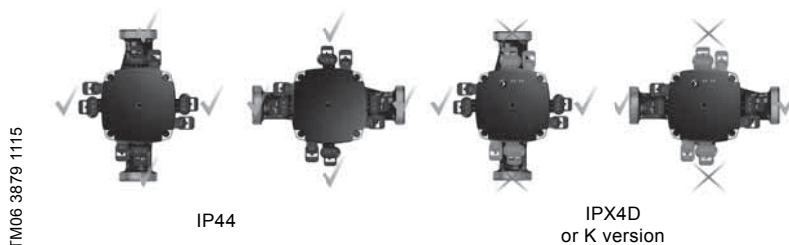

TM06 3879 1115

Control box position

TM06 3880 1115

Pump type	Dimensions [mm]							Connections [inch]	Weight [kg]
	L1	L3	B1	B2	H1	H2	H3		
UPM3(K) DHW 15-20 CIL3 PPS	130	90	72	45	36	92	128	R 1/2 / G 1	1.3

Technical data

System pressure	Max. 1.0 MPa (10 bar)	Enclosure class	IP44 (non-condensing) K: IPX4D (condensing)
Minimum inlet pressure	0.05 MPa (0.50 bar) at 95 °C liquid temperature	Motor protection	No external protection needed
Liquid temperature	+2 °C to +95 °C (TF95)	Approval and marking	VDE, CE, drinking water approvals KTW (DE), DVGW W270 (DE), ACS (FR), WRAS (GB)
Temporary hardness	Max. 3 mmol/l CaCO ₃ (16.8 ° dH)		

UPM3(K) SOLAR 15-145 130, 25-145 130, 25-145 180 (GFNJB)

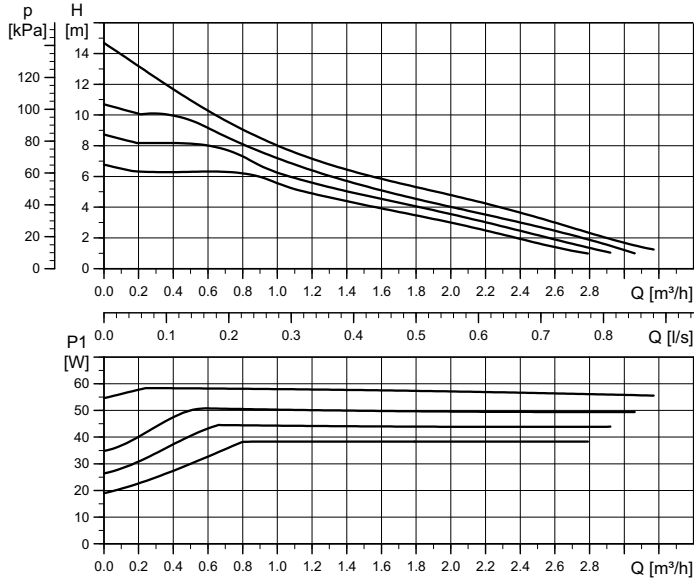

High efficiency

Setting	Max. head _{nom}
Curve 1	6.5 m
Curve 2	8.5 m
Curve 3	10.5 m
Curve 4	14.5 m

Setting	Max. P ₁ nom
Curve 1	39 W
Curve 2	45 W
Curve 3	52 W
Curve 4	60 W

EEl ≤ 0.20 Part 3
P_{L,avg} ≤ 25 W

TM06 3652 0815

Performance curve

Electrical data, 1 x 230 V, 50 Hz		
Speed	P ₁ [W]	I _{1/1} [A]
Min.	2	0.04
Max.	60	0.58

Settings				
PWM A	PWM C	PP	CP	CC
-	4	-	-	4

Note: PWM speed curves on request.

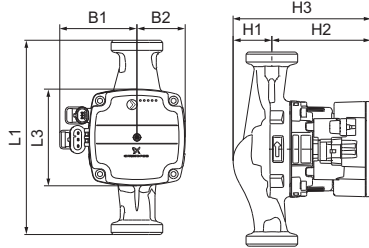

TM06 3879 1115

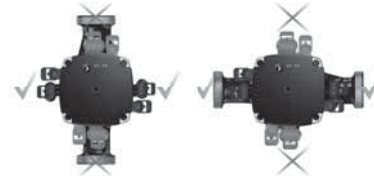

TM06 4200 1115

Dimensions

Control box position

Pump type	Dimensions [mm]							Connections [inch]	Weight [kg]
	L1	L3	B1	B2	H1	H2	H3		
UPM3(K) SOLAR 15-145 130	130	90	72	47	25.5	102	127.5	R 1/2 / G 1	1.8
UPM3(K) SOLAR 25-145 130	130	90	72	47	25.5	102	127.5	R 1 / G 1 1/2	1.9
UPM3(K) SOLAR 25-145 180	180	90	72	47	25.5	102	127.5	R 1 / G 1 1/2	2.0

Technical data

System pressure	Max. 1.0 MPa (10 bar)	Enclosure class	IPX4D
Minimum inlet pressure	0.05 MPa (0.50 bar) at 95 °C liquid temperature	Motor protection	No external protection needed
Liquid temperature	+2 °C to +110 °C (TF110) Max. 130 °C (60 °C ambient temperature)	Approval and marking	VDE, CE

UPM3(K) SOLAR 15-105 130, 25-105 130, 25-105 180 (GFNJB)

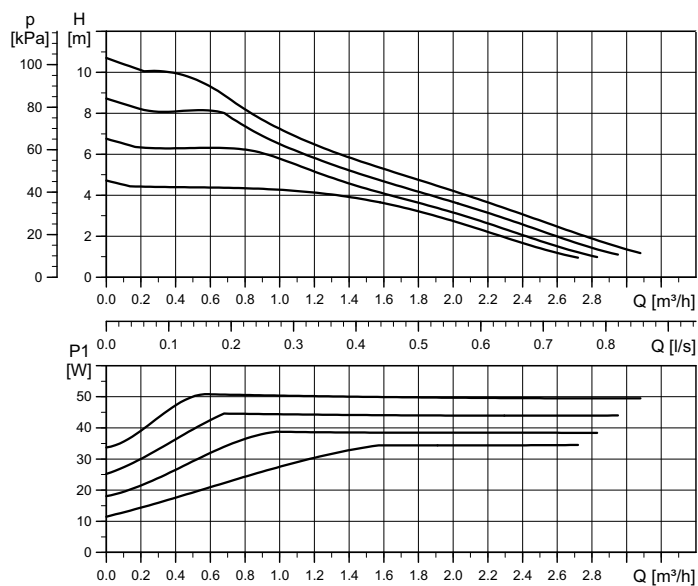

High efficiency

Setting	Max. head _{nom}
Curve 1	4.5 m
Curve 2	6.5 m
Curve 3	8.5 m
Curve 4	10.5 m

Setting	Max. P ₁ nom
Curve 1	35 W
Curve 2	39 W
Curve 3	45 W
Curve 4	52 W

EEl ≤ 0.20 Part 3
P_{L,avg} ≤ 22 W

TM06 3651 0815

Performance curve

Electrical data, 1 x 230 V, 50 Hz		
Speed	P ₁ [W]	I _{1/1} [A]
Min.	2	0.04
Max.	52	0.52

Settings				
PWM A	PWM C	PP	CP	CC
-	4	-	-	4

Note: PWM speed curves on request.

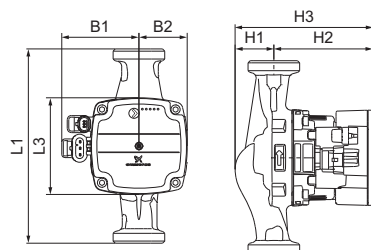

TM06 3879 1115

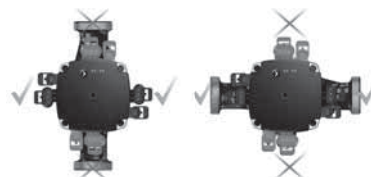

TM06 4200 1115

Dimensions

Control box position

Pump type	Dimensions [mm]							Connections [inch]	Weight [kg]
	L1	L3	B1	B2	H1	H2	H3		
UPM3(K) SOLAR 15-105 130	130	90	72	47	25.5	102	127.5	R 1/2 / G 1	1.8
UPM3(K) SOLAR 25-105 130	130	90	72	47	25.5	102	127.5	R 1 / G 1 1/2	1.9
UPM3(K) SOLAR 25-105 180	180	90	72	47	25.5	102	127.5	R 1 / G 1 1/2	2.0

Technical data

System pressure	Max. 1.0 MPa (10 bar)	Enclosure class	IPX4D
Minimum inlet pressure	0.05 MPa (0.50 bar) at 95 °C liquid temperature	Motor protection	No external protection needed
Liquid temperature	+2 °C to +110 °C (TF110) Max. 130 °C (60 °C ambient temperature)	Approval and marking	VDE, CE

UPM3(K) SOLAR 15-75 130 (N), 25-75 130 (N), 25-75 180 (N), 32-75 180 (N) (GFNJB)

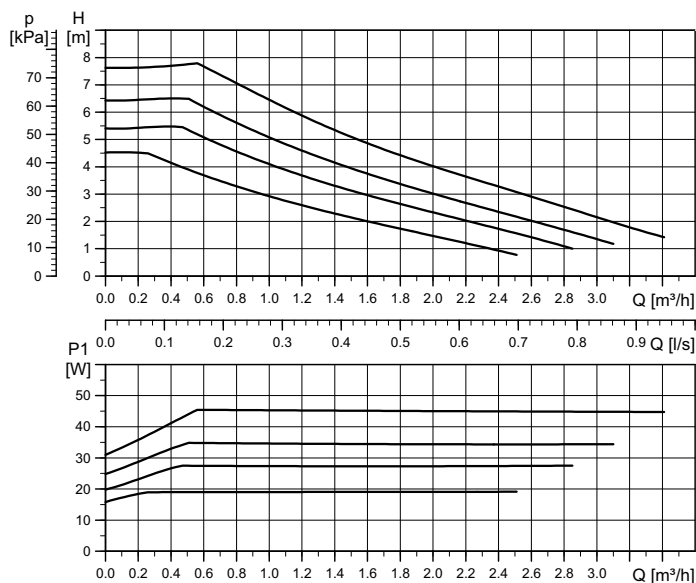

High efficiency

Setting	Max. head _{nom}
Curve 1	4.5 m
Curve 2	5.5 m
Curve 3	6.5 m
Curve 4	7.5 m

Setting	Max. P _{1 nom}
Curve 1	19 W
Curve 2	28 W
Curve 3	35 W
Curve 4	45 W

EEL ≤ 0.20 Part 3
P_{L,avg} ≤ 20 W

TM06 3658 0815

Performance curve

Electrical data, 1 x 230 V, 50 Hz		
Speed	P ₁ [W]	I _{1/1} [A]
Min.	2	0.04
Max.	45	0.48

Settings				
PWM A	PWM C	PP	CP	CC
-	4	-	-	4

Note: PWM speed curves on request.

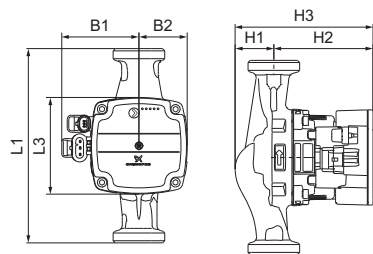

TM06 3879 1115

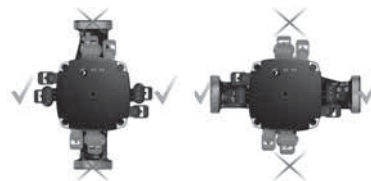

TM06 4200 1115

Dimensions

Control box position

Pump type	Dimensions [mm]							Connections [inch]	Weight [kg]
	L1	L3	B1	B2	H1	H2	H3		
UPM3(K) SOLAR 15-75 130 (N)	130	90	72	45	36	92	128	R 1/2 / G 1	1.8
UPM3(K) SOLAR 25-75 130 (N)	130	90	72	45	36	92	128	R 1 / G 1 1/2	1.9
UPM3(K) SOLAR 25-75 180 (N)	180	90	72	45	36	92	128	R 1 / G 1 1/2	2.0
UPM3(K) SOLAR 32-75 180 (N)	180	90	72	45	36	92	128	R 1 1/4 / G 2	2.2

Technical data

System pressure	Max. 1.0 MPa (10 bar)	Enclosure class	IPX4D
Minimum inlet pressure	0.05 MPa (0.50 bar) at 95 °C liquid temperature	Motor protection	No external protection needed
Liquid temperature	+2 °C to +110 °C (TF110) Max. 130 °C (60 °C ambient temperature)	Approval and marking	VDE, CE

UPM3(K) FLEX AS 15-75 CIL3 (GFNJB)

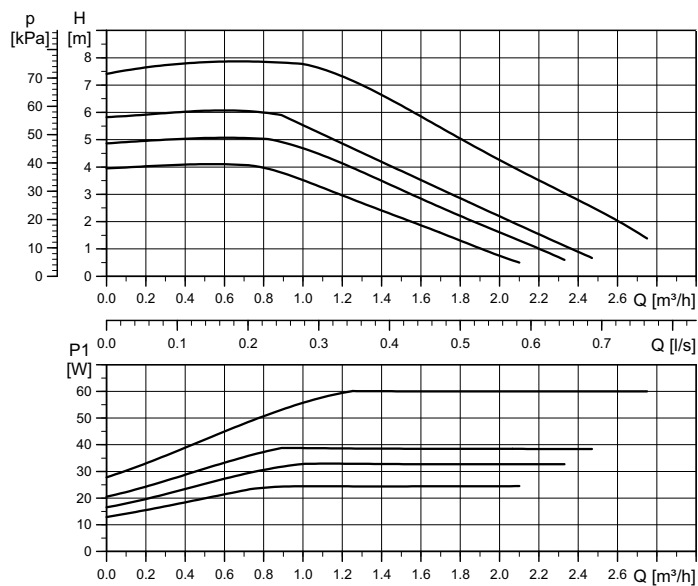

High efficiency

Setting	Max. head _{nom}
Curve 1	4 m
Curve 2	5 m
Curve 3	6 m
Curve 4	7.5 m

Setting	Max. P ₁ nom
Curve 1	25 W
Curve 2	33 W
Curve 3	39 W
Curve 4	60 W

EEl ≤ 0.20 Part 3
P_{L,avg} ≤ 28 W

TM06 3869 1115

Performance curve

Electrical data, 1 x 230 V, 50 Hz		
Speed	P ₁ [W]	I _{1/1} [A]
Min.	2	0.04
Max.	60	0.58

Settings				
PWM A	PWM C	PP	CP	CC
4	-	-	-	-

Note: PWM speed curves on request.

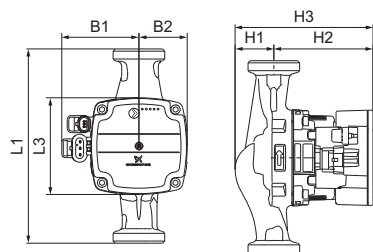

Dimensions

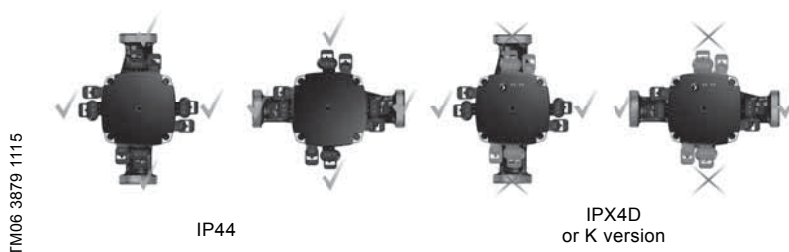

Control box position

Pump type	Dimensions [mm]							Connections [inch]	Weight [kg]
	L1	L3	B1	B2	H1	H2	H3		
UPM3(K) FLEX AS 15-75 CIL3	130	90	72	45	28	96	124	R 1/2 / G 1	1.3

Technical data

System pressure	PA 6.6: Max. 0.3 MPa (3 bar) PPS: Max. 1.0 MPa (10 bar)	Enclosure class	IP44 (non-condensing) K: IPX4D (condensing)
Minimum inlet pressure	0.05 MPa (0.50 bar) at 95 °C liquid temperature	Motor protection	No external protection needed
Liquid temperature	+2 °C to +95 °C (TF95)	Approval and marking	VDE, CE

UPM3(K) FLEX AS 15-75 GGES3 (GFNJB)

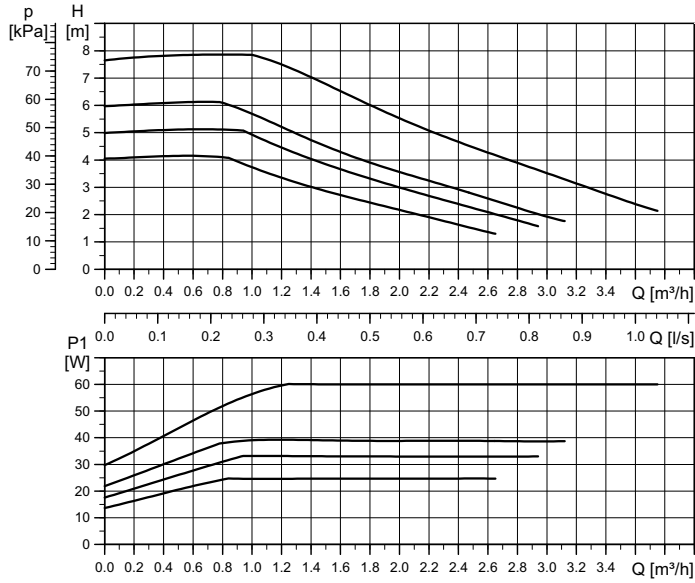

High efficiency

Setting	Max. head _{nom}
Curve 1	4 m
Curve 2	5 m
Curve 3	6 m
Curve 4	7.5 m

Setting	Max. P _{1 nom}
Curve 1	25 W
Curve 2	33 W
Curve 3	39 W
Curve 4	60 W

EEI ≤ 0.20 Part 3
P_{L,avg} ≤ 28 W

TM06 3870 1115

Performance curve

Electrical data, 1 x 230 V, 50 Hz		
Speed	P ₁ [W]	I _{1/1} [A]
Min.	2	0.04
Max.	60	0.58

Settings				
PWM A	PWM C	PP	CP	CC
4	-	-	-	-

Note: PWM speed curves on request.

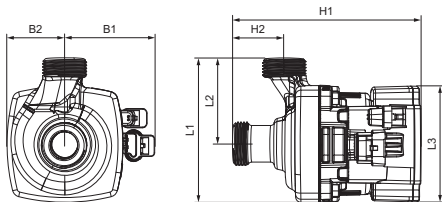

Dimensions

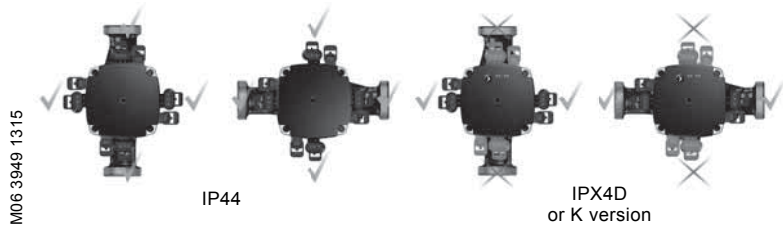

Control box position

TM06 3949 1315

TM06 3880 1115

Pump type	Dimensions [mm]							Connections [inch]	Weight [kg]
	L1	L2	L3	B1	B2	H1	H2		
UPM3(K) FLEX AS 15-75 GGES3	110	65	90	72	47	141	39	R 1/2 / G 1	2.0

Technical data

System pressure	Max. 1.0 MPa (10 bar)	Enclosure class	IP44 (non-condensing) K: IPX4D (condensing)
Minimum inlet pressure	0.05 MPa (0.50 bar) at 95 °C liquid temperature	Motor protection	No external protection needed
Liquid temperature	+2 °C to +110 °C (TF110)	Approval and marking	VDE, CE

UPM3(K) FLEX AS 15-75 GGMBP3 (GFNJJB)

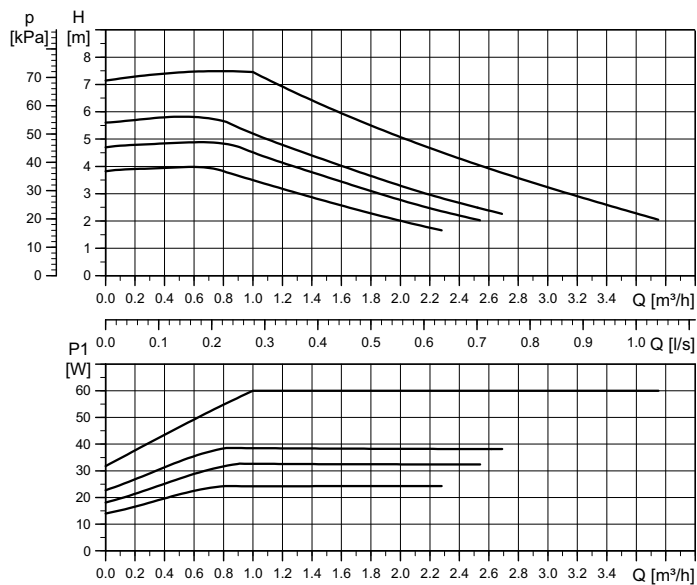

High efficiency

Setting	Max. head _{nom}
Curve 1	4 m
Curve 2	5 m
Curve 3	6 m
Curve 4	7.5 m

Setting	Max. P ₁ nom
Curve 1	25 W
Curve 2	33 W
Curve 3	39 W
Curve 4	60 W

EEl ≤ 0.20 Part 3
P_{L,avg} ≤ 28 W

TM06 4091 1515

Performance curve

Electrical data, 1 x 230 V, 50 Hz		
Speed	P ₁ [W]	I _{1/1} [A]
Min.	2	0.04
Max.	60	0.58

Settings				
PWM A	PWM C	PP	CP	CC
4	-	-	-	-

Note: PWM speed curves on request.

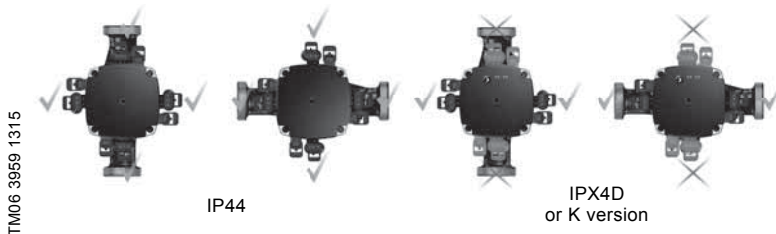
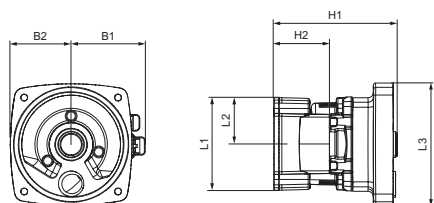

Dimensions

Control box position

Pump type	Dimensions [mm]							Connections [mm]	Weight [kg]
	L1	L2	L3	B1	B2	H1	H2		
UPM3(K) FLEX AS 15-75 GGMBP3	93	46.5	90	72	47	114	48.5	19/26	2.2

Technical data

System pressure	Max. 1.0 MPa (10 bar)	Enclosure class	IP44 (non-condensing) K: IPX4D (condensing)
Minimum inlet pressure	0.05 MPa (0.50 bar) at 95 °C liquid temperature	Motor protection	No external protection needed
Liquid temperature	+2 °C to +110 °C (TF110)	Approval and marking	VDE, CE

UPM3(K) FLEX AS 15-75 GGBP3 (GFNJB)

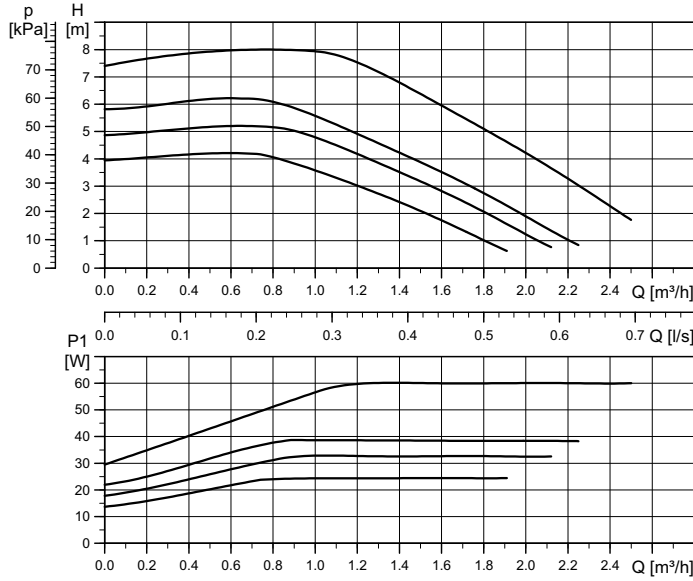

High efficiency

Setting	Max. head _{nom}
Curve 1	4 m
Curve 2	5 m
Curve 3	6 m
Curve 4	7.5 m

Setting	Max. P ₁ nom
Curve 1	25 W
Curve 2	33 W
Curve 3	39 W
Curve 4	60 W

EEI ≤ 0.20 Part 3
P_{L,avg} ≤ 28 W

TM06 3871 1115

Performance curve

Electrical data, 1 x 230 V, 50 Hz		
Speed	P ₁ [W]	I _{1/1} [A]
Min.	2	0.04
Max.	60	0.58

Settings				
PWM A	PWM C	PP	CP	CC
4	-	-	-	-

Note: PWM speed curves on request.

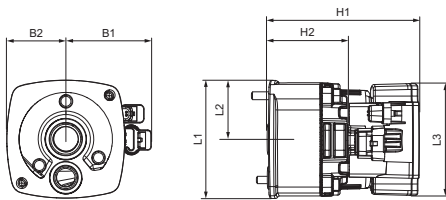

Dimensions

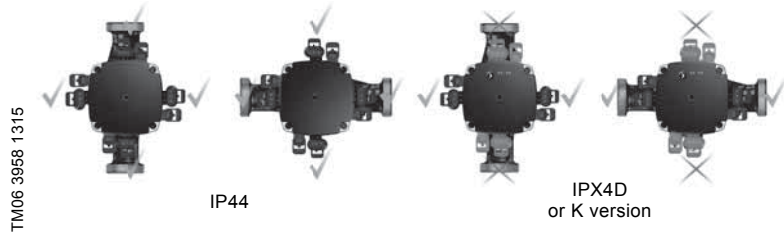

Control box position

TM06 3958 1315

TM06 3880 1115

Pump type	Dimensions [mm]							Connections [mm]	Weight [kg]
	L1	L2	L3	B1	B2	H1	H2		
UPM3(K) FLEX AS 15-75 GGBP3	117	58.5	90	72	58.5	115	39	2 x 24.5	2.7

Technical data

System pressure	Max. 1.0 MPa (10 bar)	Enclosure class	IP44 (non-condensing) K: IPX4D (condensing)
Minimum inlet pressure	0.05 MPa (0.50 bar) at 95 °C liquid temperature	Motor protection	No external protection needed
Liquid temperature	+2 °C to +110 °C (TF110)	Approval and marking	VDE, CE

UPM3(K) FLEX AS 15-75 GGAOS3 (GFNJB)

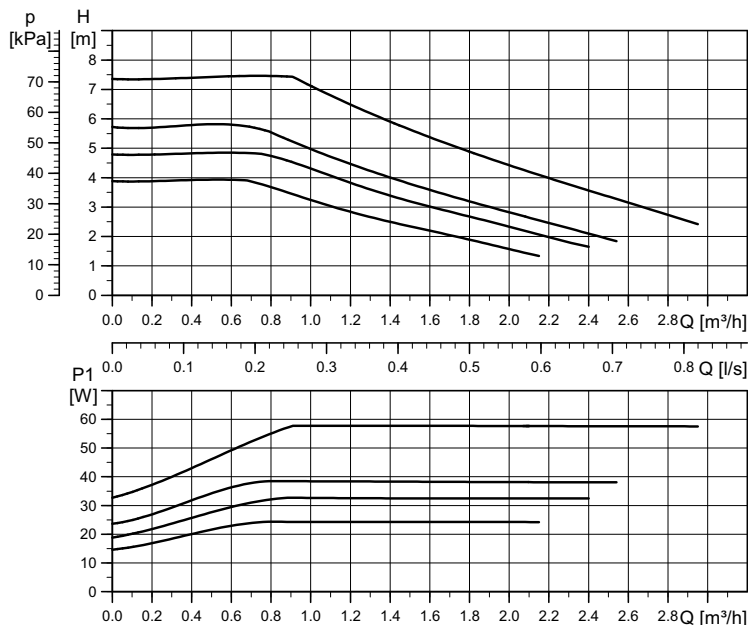

High efficiency

Setting	Max. head _{nom}
Curve 1	4 m
Curve 2	5 m
Curve 3	6 m
Curve 4	7.5 m

Setting	Max. P ₁ nom
Curve 1	25 W
Curve 2	33 W
Curve 3	39 W
Curve 4	60 W

EEl ≤ 0.20 Part 3
P_{L,avg} ≤ 28 W

TM06 8620 0917

Performance curve

Electrical data, 1 x 230 V, 50 Hz		
Speed	P ₁ [W]	I _{1/1} [A]
Min.	2	0.04
Max.	60	0.58

Settings				
PWM A	PWM C	PP	CP	CC
4	-	-	-	-

Note: PWM speed curves on request.

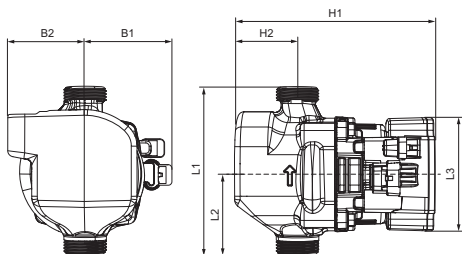

Dimensions

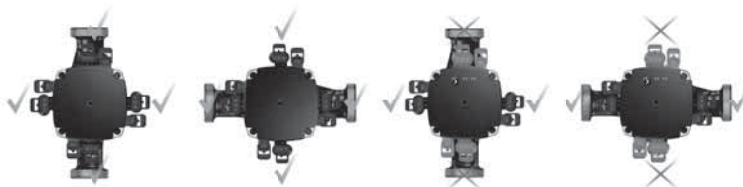

Control box position

TM06 8474 0717

TM06 3880 1115

Pump type	Dimensions [mm]							Connections [inch]	Weight [kg]
	L1	L2	L3	B1	B2	H1	H2		
UPM3(K) FLEX AS 15-75 GGAOS3	130	62	90	72	58	151	47	R 1/2 / G 1 Rp 3/8	1.8

Technical data

System pressure	Max. 1.0 MPa (10 bar)	Enclosure class	IP44 (non-condensing) K: IPX4D (condensing)
Minimum inlet pressure	0.05 MPa (0.50 bar) at 95 °C liquid temperature	Motor protection	No external protection needed
Liquid temperature	+2 °C to +110 °C (TF110)	Approval and marking	VDE, CE

UPM3(K) FLEX AS 15-75 CIAO2 (GFNJB)

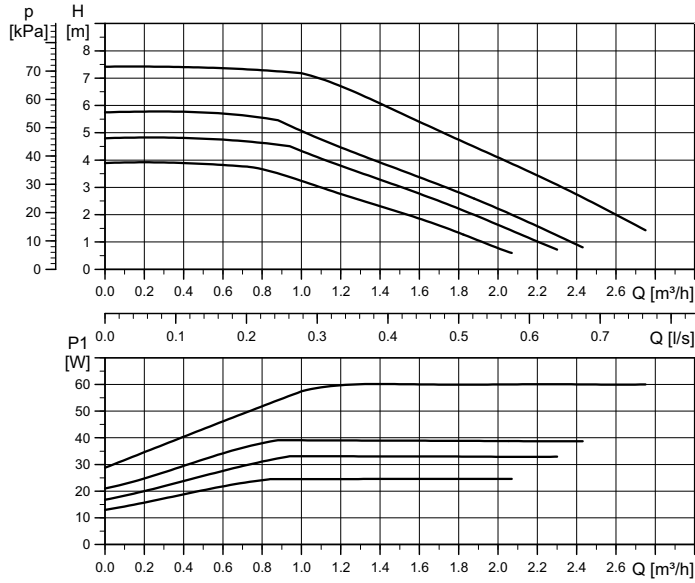

High efficiency

Setting	Max. head _{nom}
Curve 1	4 m
Curve 2	5 m
Curve 3	6 m
Curve 4	7.5 m

Setting	Max. P ₁ nom
Curve 1	25 W
Curve 2	33 W
Curve 3	39 W
Curve 4	60 W

EEl ≤ 0.20 Part 3
P_{L,avg} ≤ 28 W

TM06 3868 1115

Performance curve

Electrical data, 1 x 230 V, 50 Hz		
Speed	P ₁ [W]	I _{1/1} [A]
Min.	2	0.04
Max.	60	0.58

Settings				
PWM A	PWM C	PP	CP	CC
4	-	-	-	-

Note: PWM speed curves on request.

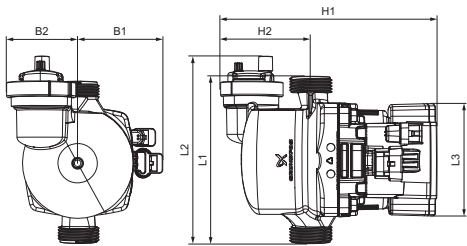

Dimensions

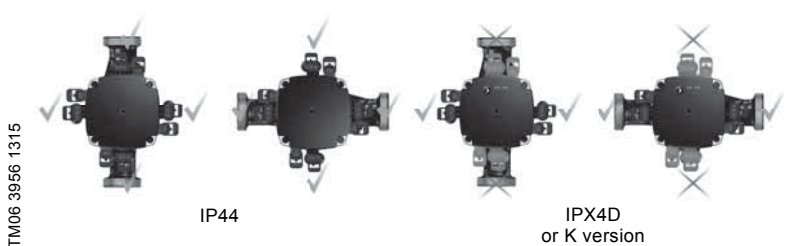

Control box position

TM06 3868 1115

Pump type	Dimensions [mm]							Connections [inch]	Weight [kg]
	L1	L2	L3	B1	B2	H1	H2		
UPM3(K) FLEX AS 15-75 CIAO2	130	148	90	72	55	173	77	R 1/2 / G 1	1.3

Technical data

System pressure	Max. 0.3 MPa (3 bar)	Enclosure class	IP44 (non-condensing) K: IPX4D (condensing)
Minimum inlet pressure	0.05 MPa (0.50 bar) at 95 °C liquid temperature	Motor protection	No external protection needed
Liquid temperature	+2 °C to +95 °C (TF95)	Approval and marking	VDE, CE

UPM3(K) FLEX AS 15-75 CIAO2 AC (GFNJJB)

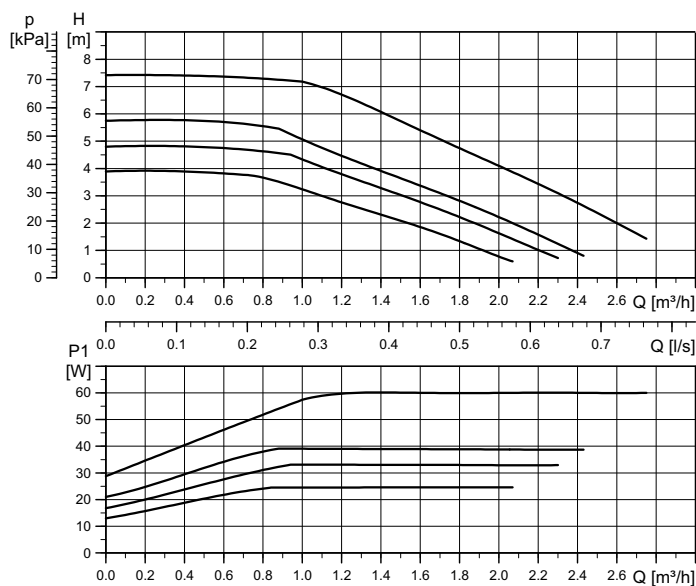

High efficiency

Setting	Max. head _{nom}
Curve 1	4 m
Curve 2	5 m
Curve 3	6 m
Curve 4	7.5 m

Setting	Max. P ₁ nom
Curve 1	25 W
Curve 2	33 W
Curve 3	39 W
Curve 4	60 W

EEl ≤ 0.20 Part 3
P_{L,avg} ≤ 28 W

TM06 3868 1115

Performance curve

Electrical data, 1 x 230 V, 50 Hz		
Speed	P ₁ [W]	I _{1/1} [A]
Min.	2	0.04
Max.	60	0.58

Settings				
PWM A	PWM C	PP	CP	CC
4	-	-	-	-

Note: PWM speed curves on request.

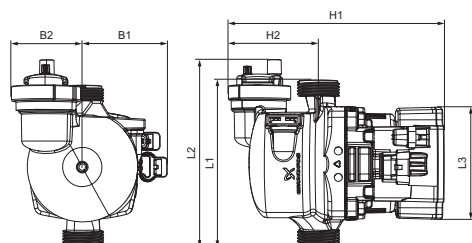

Dimensions

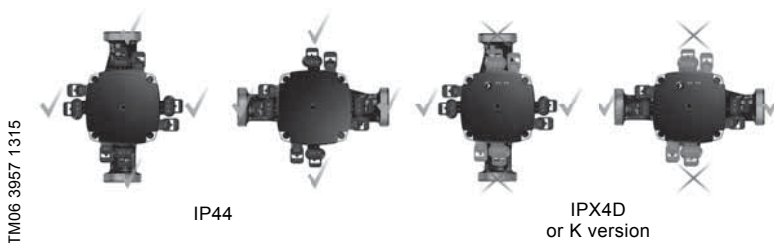

Control box position

TM06 3868 1115

Pump type	Dimensions [mm]							Connections [inch / mm]	Weight [kg]
	L1	L2	L3	B1	B2	H1	H2		
UPM3(K) FLEX AS 15-75 CIAO2 AC	130	148	90	72	55	173	77	2 x G 1 + D 10	1.3

Technical data

System pressure	Max. 0.3 MPa (3 bar)	Enclosure class	IP44 (non-condensing) K: IPX4D (condensing)
Minimum inlet pressure	0.05 MPa (0.50 bar) at 95 °C liquid temperature	Motor protection	No external protection needed
Liquid temperature	+2 °C to +95 °C (TF95)	Approval and marking	VDE, CE

UPM3(K) FLEX AS 15-75 CES3 (GFNJB)

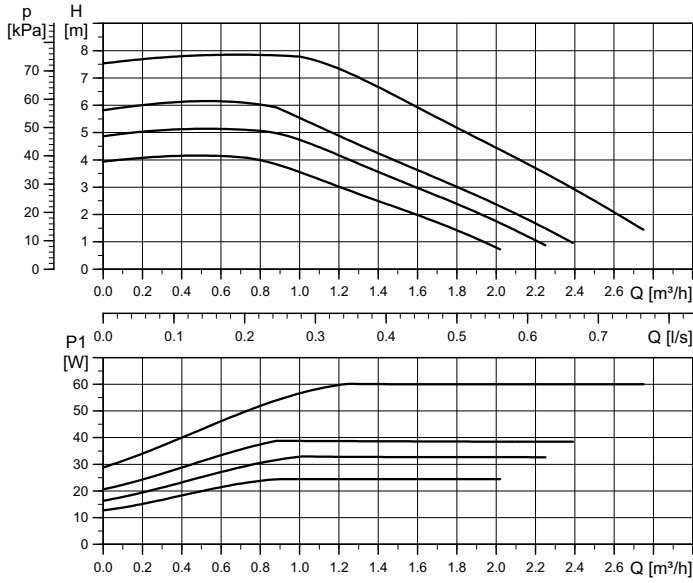

High efficiency

Setting	Max. head _{nom}
Curve 1	4 m
Curve 2	5 m
Curve 3	6 m
Curve 4	7.5 m

Setting	Max. P ₁ nom
Curve 1	25 W
Curve 2	33 W
Curve 3	39 W
Curve 4	60 W

EEl ≤ 0.20 Part 3
P_{L,avg} ≤ 28 W

TM06 3863 1115

Performance curve

Electrical data, 1 x 230 V, 50 Hz		
Speed	P ₁ [W]	I _{1/1} [A]
Min.	2	0.04
Max.	60	0.58

Settings				
PWM A	PWM C	PP	CP	CC
4	-	-	-	-

Note: PWM speed curves on request.

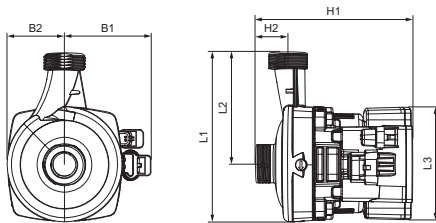

Dimensions

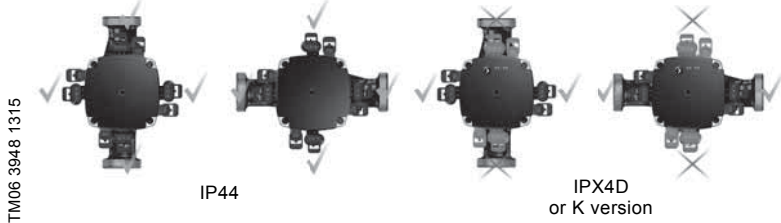

Control box position

TM06 3948 1315

TM06 3860 1115

Pump type	Dimensions [mm]							Connections [inch]	Weight [kg]
	L1	L2	L3	B1	B2	H1	H2		
UPM3(K) FLEX AS 15-75 CES3	132	87	90	72	47	120	25	R 1/2 / G 1	1.2

Technical data

System pressure	Max. 0.3 MPa (3 bar)	Enclosure class	IP44 (non-condensing) K: IPX4D (condensing)
Minimum inlet pressure	0.05 MPa (0.50 bar) at 95 °C liquid temperature	Motor protection	No external protection needed
Liquid temperature	+2 °C to +95 °C (TF95)	Approval and marking	VDE, CE

UPM3(K) FLEX AS 15-75 CACAO (GFNJB)

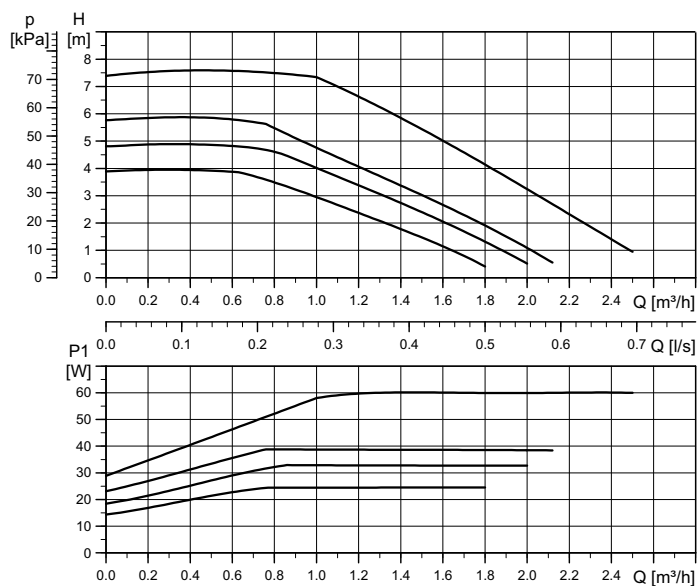

High efficiency

Setting	Max. head _{nom}
Curve 1	4 m
Curve 2	5 m
Curve 3	6 m
Curve 4	7.5 m

Setting	Max. P ₁ nom
Curve 1	25 W
Curve 2	33 W
Curve 3	39 W
Curve 4	60 W

EEl ≤ 0.20 Part 3
P_{L,avg} ≤ 28 W

TM06 3862 1115

Performance curve

Electrical data, 1 x 230 V, 50 Hz		
Speed	P ₁ [W]	I _{1/1} [A]
Min.	2	0.04
Max.	60	0.58

Settings				
PWM A	PWM C	PP	CP	CC
4	-	-	-	-

Note: PWM speed curves on request.

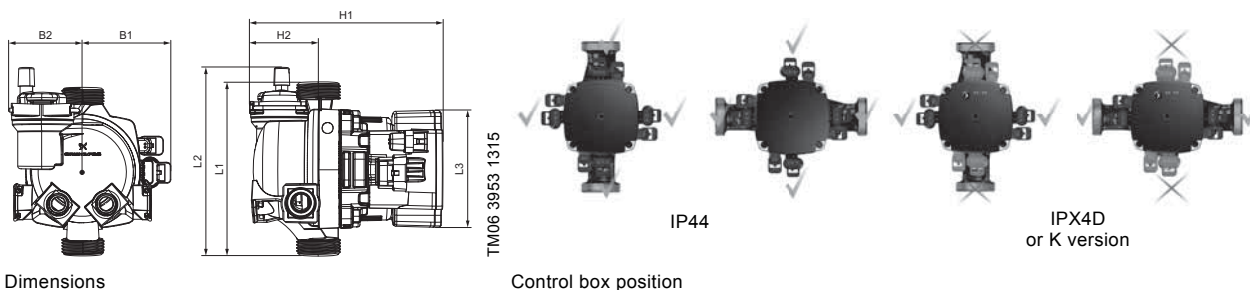

Dimensions

Control box position

TM06 3880 1115

Pump type	Dimensions [mm]							Connections [inch / mm]	Weight [kg]
	L1	L2	L3	B1	B2	H1	H2		
UPM3(K) FLEX AS 15-75 CACAO	130	137	90	72	54	144	53	2 x G 1 2 x D 14 2 x D 10	1.3

Technical data

System pressure	Max. 0.3 MPa (3 bar)	Enclosure class	IP44 (non-condensing) K: IPX4D (condensing)
Minimum inlet pressure	0.05 MPa (0.50 bar) at 95 °C liquid temperature	Motor protection	No external protection needed
Liquid temperature	+2 °C to +95 °C (TF95)	Approval and marking	VDE, CE

UPM3(K) FLEX AS 15-75 CESAO1 (GFNJJB)

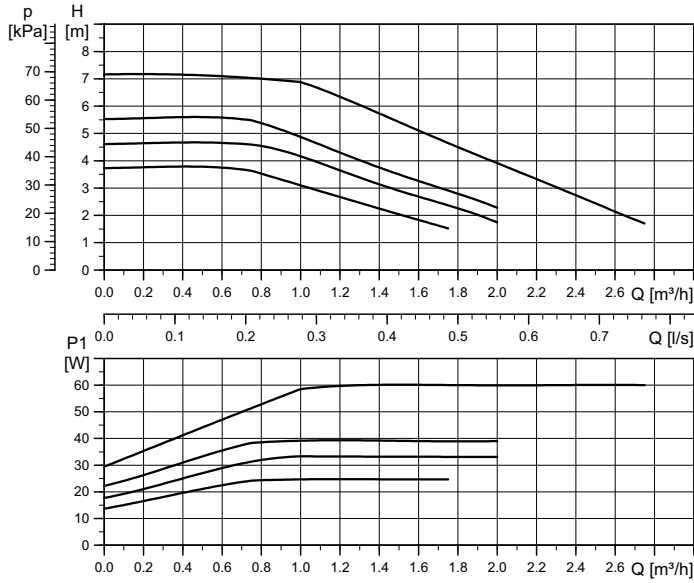

High efficiency

Setting	Max. head _{nom}
Curve 1	4 m
Curve 2	5 m
Curve 3	6 m
Curve 4	7.5 m

Setting	Max. P ₁ nom
Curve 1	25 W
Curve 2	33 W
Curve 3	39 W
Curve 4	60 W

EEI ≤ 0.20 Part 3
P_{L,avg} ≤ 28 W

TM06 3864 1115

Performance curve

Electrical data, 1 x 230 V, 50 Hz		
Speed	P ₁ [W]	I _{1/1} [A]
Min.	2	0.04
Max.	60	0.58

Settings				
PWM A	PWM C	PP	CP	CC
4	-	-	-	-

Note: PWM speed curves on request.

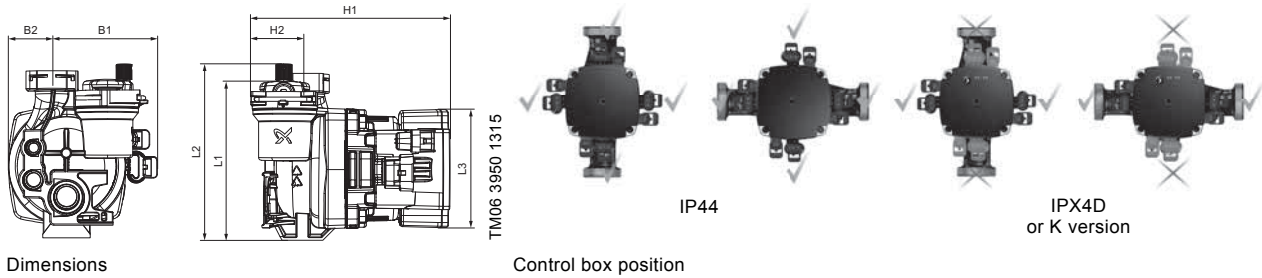

Dimensions

Control box position

TM06 3860 1115

Pump type	Dimensions [mm]							Connections [mm]	Weight [kg]
	L1	L2	L3	B1	B2	H1	H2		
UPM3(K) FLEX AS 15-75 CESAO1	124	128	90	72	45	144	45	2 x D 18 / D 10 / D 6	1.3

Technical data

System pressure	Max. 0.3 MPa (3 bar)	Enclosure class	IP44 (non-condensing) K: IPX4D (condensing)
Minimum inlet pressure	0.05 MPa (0.50 bar) at 95 °C liquid temperature	Motor protection	No external protection needed
Liquid temperature	+2 °C to +95 °C (TF95)	Approval and marking	VDE, CE

UPM3(K) FLEX AS 15-75 CESAO2 (GFNJB)

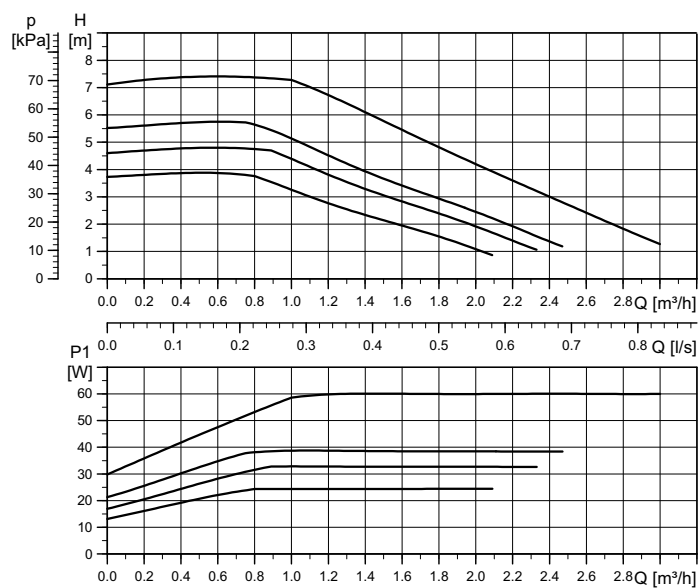

High efficiency

Setting	Max. head _{nom}
Curve 1	4 m
Curve 2	5 m
Curve 3	6 m
Curve 4	7.5 m

Setting	Max. P ₁ nom
Curve 1	25 W
Curve 2	33 W
Curve 3	39 W
Curve 4	60 W

EEl ≤ 0.20 Part 3
P_{L,avg} ≤ 28 W

TM06 3865 1115

Performance curve

Electrical data, 1 x 230 V, 50 Hz		
Speed	P ₁ [W]	I _{1/1} [A]
Min.	2	0.04
Max.	60	0.58

Settings				
PWM A	PWM C	PP	CP	CC
4	-	-	-	-

Note: PWM speed curves on request.

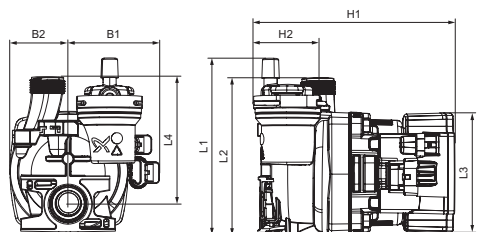

Dimensions

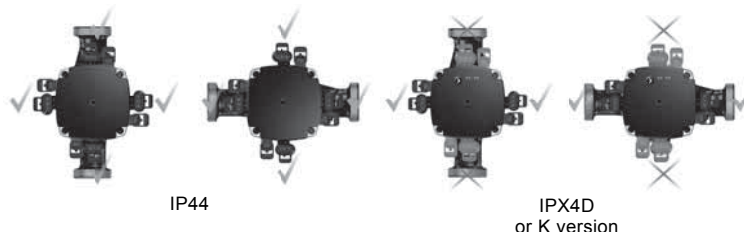

Control box position

Pump type	Dimensions [mm]								Connections [inch / mm]	Weight [kg]
	L1	L2	L3	L4	B1	B2	H1	H2		
UPM3(K) FLEX AS 15-75 CESAO2	138	116	90	87	72	45	144	45	G 3/4 / D 18 / D 10 / D 6	1.3

Technical data

System pressure	Max. 0.3 MPa (3 bar)	Enclosure class	IP44 (non-condensing) K: IPX4D (condensing)
Minimum inlet pressure	0.05 MPa (0.50 bar) at 95 °C liquid temperature	Motor protection	No external protection needed
Liquid temperature	+2 °C to +95 °C (TF95)	Approval and marking	VDE, CE

UPM3(K) FLEX AS 15-75 CESAO4 (GFNJJB)

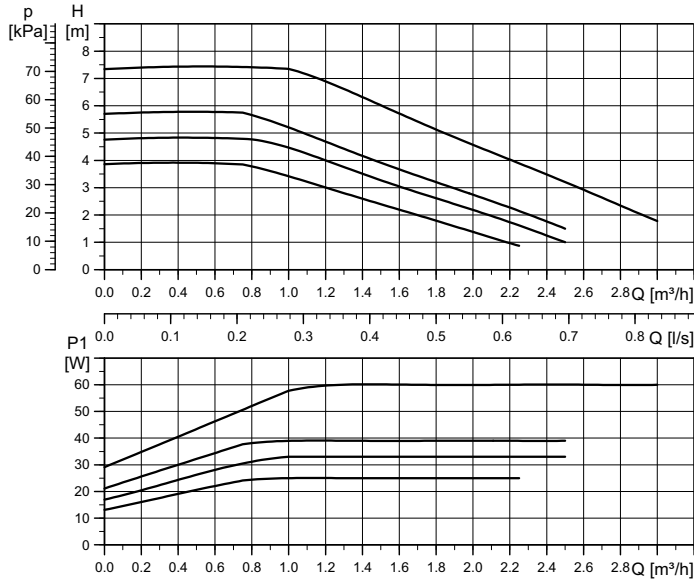

High efficiency

Setting	Max. head _{nom}
Curve 1	4 m
Curve 2	5 m
Curve 3	6 m
Curve 4	7.5 m

Setting	Max. P ₁ nom
Curve 1	25 W
Curve 2	33 W
Curve 3	39 W
Curve 4	60 W

EEl ≤ 0.20 Part 3
P_{L,avg} ≤ 28 W

TM06 3867 1115

Performance curve

Electrical data, 1 x 230 V, 50 Hz		
Speed	P ₁ [W]	I _{1/1} [A]
Min.	2	0.04
Max.	60	0.58

Settings				
PWM A	PWM C	PP	CP	CC
4	-	-	-	-

Note: PWM speed curves on request.

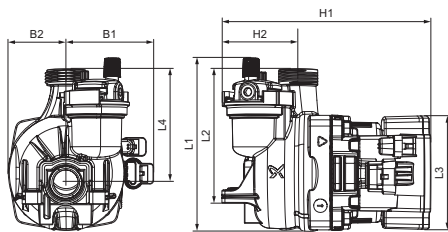

Dimensions

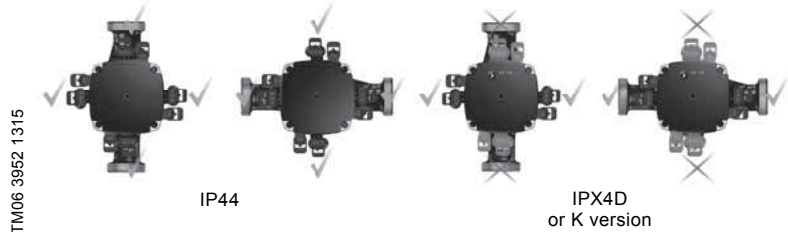

Control box position

TM06 3952 1315

TM06 3880 1115

Pump type	Dimensions [mm]								Connections [inch / mm]	Weight [kg]
	L1	L2	L3	L4	B1	B2	H1	H2		
UPM3(K) FLEX AS 15-75 CESAO4	138	126	90	93	88	29	144	45	G 1 / D 18	1.3

Technical data

System pressure	Max. 0.3 MPa (3 bar)	Enclosure class	IP44 (non-condensing) K: IPX4D (condensing)
Minimum inlet pressure	0.05 MPa (0.50 bar) at 95 °C liquid temperature	Motor protection	No external protection needed
Liquid temperature	+2 °C to +95 °C (TF95)	Approval and marking	VDE, CE

UPM3(K) FLEX AS 15-75 AOKR (GFNJB)

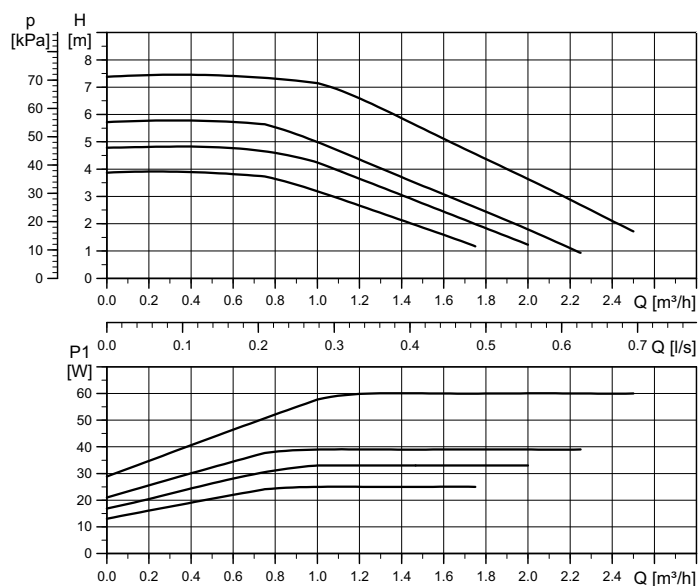

High efficiency

Setting	Max. head _{nom}
Curve 1	4 m
Curve 2	5 m
Curve 3	6 m
Curve 4	7.5 m

Setting	Max. P _{1 nom}
Curve 1	25 W
Curve 2	33 W
Curve 3	39 W
Curve 4	60 W

EEl ≤ 0.20 Part 3
P_{L,avg} ≤ 28 W

TM06 4092 1515

Performance curve

Electrical data, 1 x 230 V, 50 Hz		
Speed	P ₁ [W]	I _{1/1} [A]
Min.	2	0.04
Max.	60	0.58

Settings				
PWM A	PWM C	PP	CP	CC
4	-	-	-	-

Note: PWM speed curves on request.

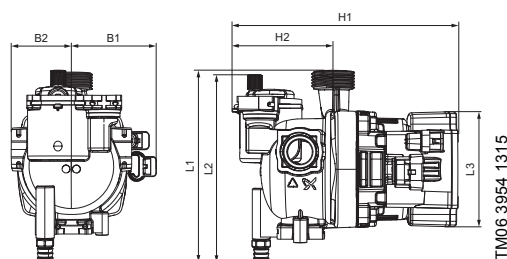

Dimensions

Control box position

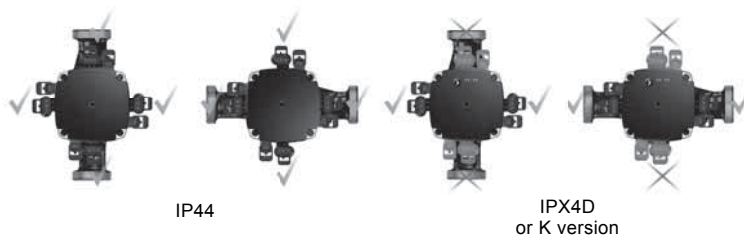

TM06 3880 1115

Pump type	Dimensions [mm]							Connections [inch / mm]	Weight [kg]
	L1	L2	L3	B1	B2	H1	H2		
UPM3(K) FLEX AS 15-75 AOKR	148	151	90	72	45	172	79	G 1 3 x D 28 D 21	1.4

Technical data

System pressure	Max. 0.3 MPa (3 bar)	Enclosure class	IP44 (non-condensing) K: IPX4D (condensing)
Minimum inlet pressure	0.05 MPa (0.50 bar) at 95 °C liquid temperature	Motor protection	No external protection needed
Liquid temperature	+2 °C to +95 °C (TF95)	Approval and marking	VDE, CE

UPM3(K) FLEX AS 15-75 CAOD (GFNJB)

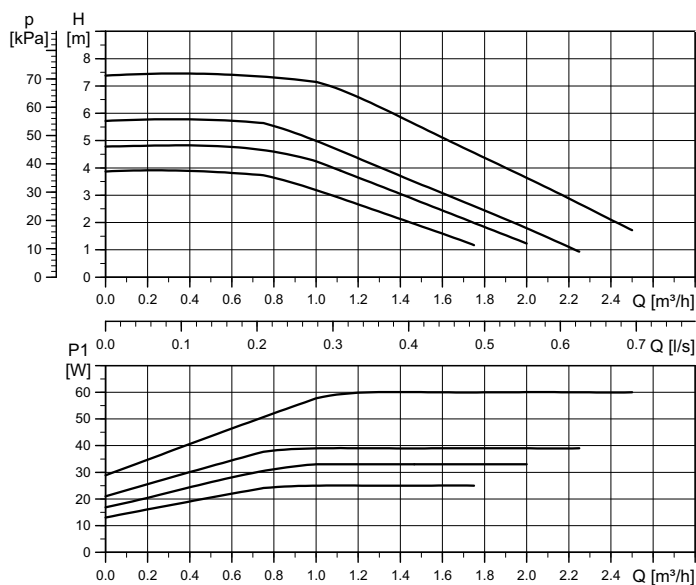

High efficiency

Setting	Max. head _{nom}
Curve 1	4 m
Curve 2	5 m
Curve 3	6 m
Curve 4	7.5 m

Setting	Max. P ₁ nom
Curve 1	25 W
Curve 2	33 W
Curve 3	39 W
Curve 4	60 W

EEl ≤ 0.20 Part 3
P_{L,avg} ≤ 28 W

TM06 4092 1515

Performance curve

Electrical data, 1 x 230 V, 50 Hz		
Speed	P ₁ [W]	I _{1/1} [A]
Min.	2	0.04
Max.	60	0.58

Settings				
PWM A	PWM C	PP	CP	CC
4	-	-	-	-

Note: PWM speed curves on request.

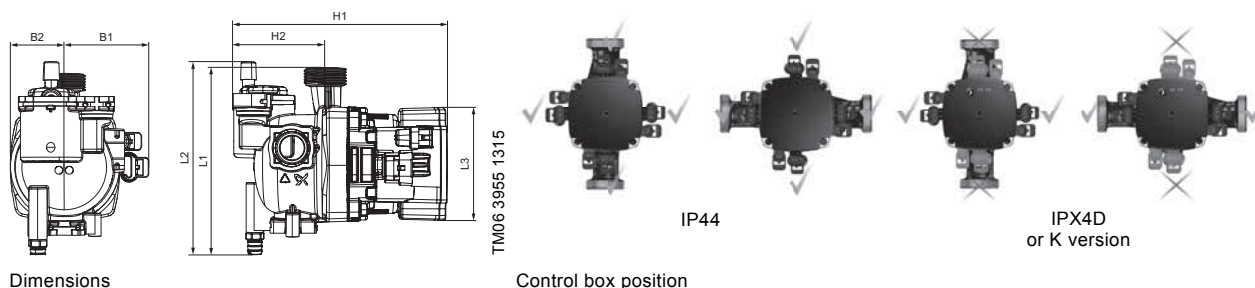

Pump type	Dimensions [mm]							Connections [inch / mm]	Weight [kg]
	L1	L2	L3	B1	B2	H1	H2		
UPM3(K) FLEX AS 15-75 CAOD	148	151	90	72	45	172	79	G 1 2 x D 28 D 21	1.4

Technical data

System pressure	Max. 0.3 MPa (3 bar)	Enclosure class	IP44 (non-condensing) K: IPX4D (condensing)
Minimum inlet pressure	0.05 MPa (0.50 bar) at 95 °C liquid temperature	Motor protection	No external protection needed
Liquid temperature	+2 °C to +95 °C (TF95)	Approval and marking	VDE, CE

UPM3S 15-40 130 (N), 25-40 130 (N), 25-40 180 (N), 32-40 180 (N) (GFNJF)

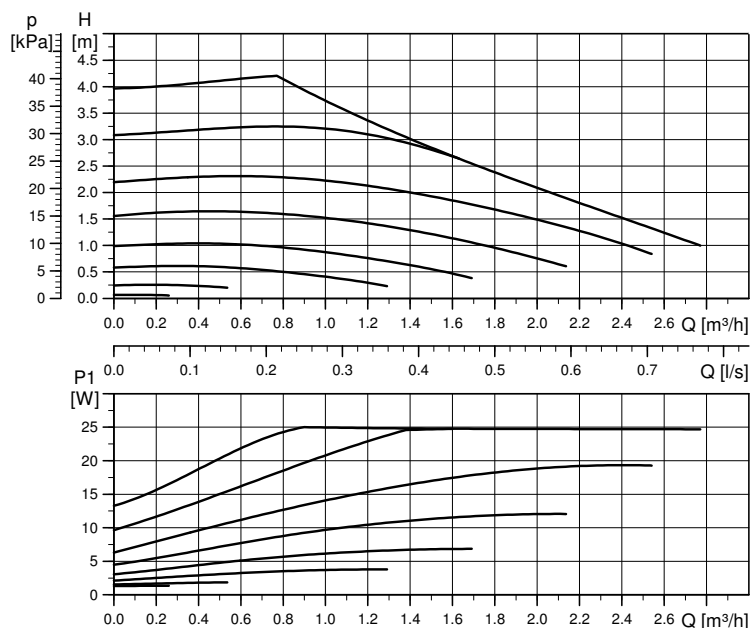

High efficiency

 $E_{EI} \leq 0.20$ Part 3
 $P_{L,avg} \leq 12$ W

TM06 8617 0917

Performance curve

Electrical data, 1 x 230 V, 50 Hz		
Speed	P_1 [W]	$I_{1/1}$ [A]
Min.	2	0.04
Max.	25	0.29

Settings

1 factory preset

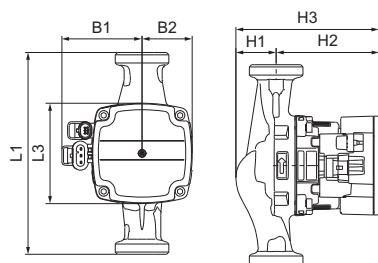

TM06 3878 1115

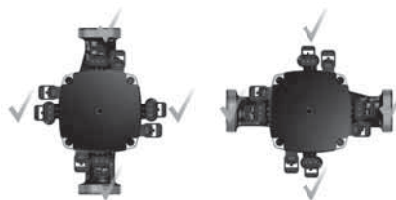

TM07 1176 1018

Dimensions

Control box position

Pump type	Dimensions [mm]							Connections [inch]	Weight [kg]
	L1	L3	B1	B2	H1	H2	H3		
UPM3S 15-40 130 (N)	130	90	72	45	36	92	128	R 1/2 / G 1	1.8
UPM3S 25-40 130 (N)	130	90	72	45	36	92	128	R 1 / G 1 1/2	1.9
UPM3S 25-40 180 (N)	180	90	72	45	36	92	128	R 1 / G 1 1/2	2.0
UPM3S 32-40 130 (N)	180	90	72	45	36	92	128	R 1 1/4 / G 2	2.2

Technical data

System pressure	Max. 1.0 MPa (10 bar)	Enclosure class	IP44 (non-condensing)
Minimum inlet pressure	0.05 MPa (0.50 bar) at 95 °C liquid temperature	Motor protection	No external protection needed
Liquid temperature	+2 °C to +110 °C (TF110)	Approval and marking	VDE, CE

UPM3S 15-50 130 (N), 25-50 130 (N), 25-50 180 (N), 32-50 180 (N) (GFNJF)

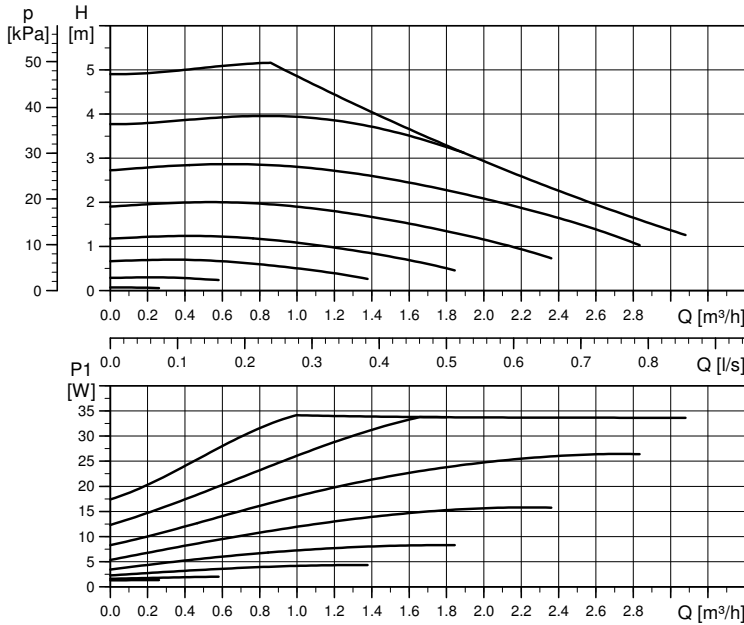

High efficiency

EEI ≤ 0.20 Part 3
P_{L,avg} ≤ 16 W

Performance curve

Electrical data, 1 x 230 V, 50 Hz		
Speed	P ₁ [W]	I _{1/1} [A]
Min.	2	0.04
Max.	34	0.36

Settings
1 factory preset

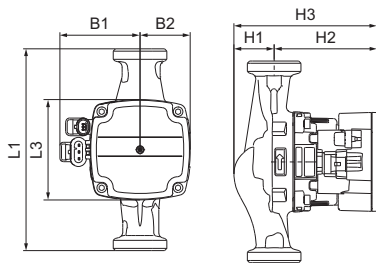

TM06 3878 1115

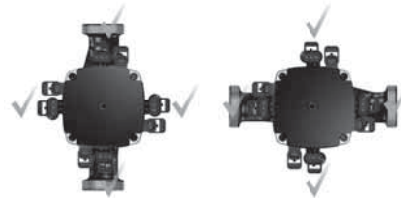

TM06 8618 0917

Dimensions

Control box position

TM07 1176 1018

Pump type	Dimensions [mm]							Connections [inch]	Weight [kg]
	L1	L3	B1	B2	H1	H2	H3		
UPM3S 15-50 130 (N)	130	90	72	45	36	92	128	R 1/2 / G 1	1.8
UPM3S 25-50 130 (N)	130	90	72	45	36	92	128	R 1 / G 1 1/2	1.9
UPM3S 25-50 180 (N)	180	90	72	45	36	92	128	R 1 / G 1 1/2	2.0
UPM3S 32-50 180 (N)	180	90	72	45	36	92	128	R 1 1/4 / G 2	2.2

Technical data

System pressure	Max. 1.0 MPa (10 bar)	Enclosure class	IP44 (non-condensing)
Minimum inlet pressure	0.05 MPa (0.50 bar) at 95 °C liquid temperature	Motor protection	No external protection needed
Liquid temperature	+2 °C to +110 °C (TF110)	Approval and marking	VDE, CE

UPM3S 15-60 130 (N), 25-60 130 (N), 25-60 180 (N), 32-60 180 (N) (GFNJF)

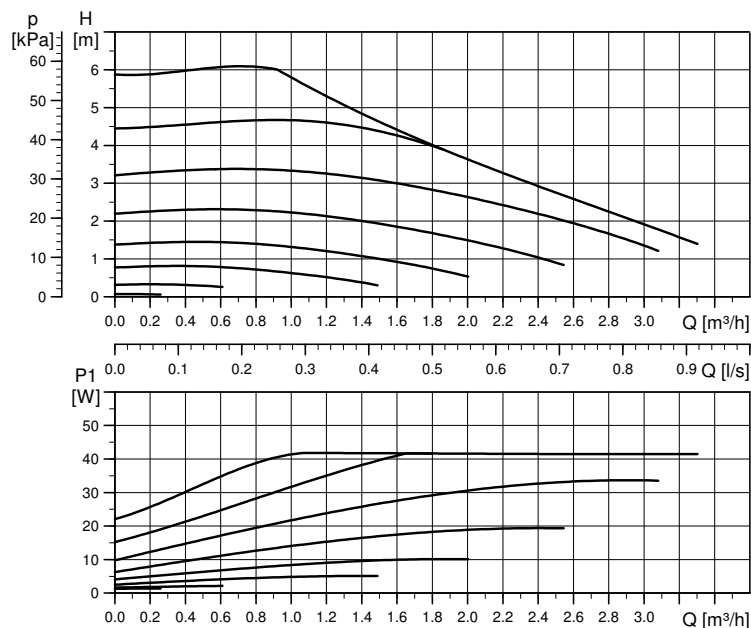

High efficiency

 $E_{EI} \leq 0.20$ Part 3
 $P_{L,avg} \leq 20$ W

TM06 8619 0917

Performance curve

Electrical data, 1 x 230 V, 50 Hz		
Speed	P_1 [W]	$I_{1/1}$ [A]
Min.	2	0.04
Max.	42	0.40

Settings

1 factory preset

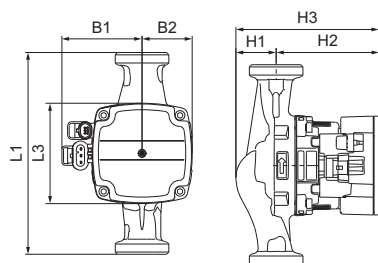

TM06 3878 1115

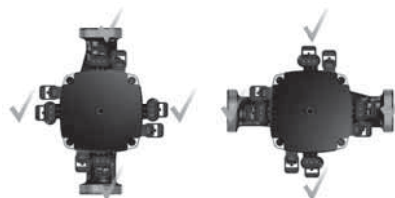

TM07 1176 1018

Dimensions

Control box position

Pump type	Dimensions [mm]							Connections [inch]	Weight [kg]
	L1	L3	B1	B2	H1	H2	H3		
UPM3S 15-60 130 (N)	130	90	72	45	36	92	128	R 1/2 / G 1	1.8
UPM3S 25-60 130 (N)	130	90	72	45	36	92	128	R 1 / G 1 1/2	1.9
UPM3S 25-60 180 (N)	180	90	72	45	36	92	128	R 1 / G 1 1/2	2.0
UPM3S 32-60 180 (N)	180	90	72	45	36	92	128	R 1 1/4 / G 2	2.2

Technical data

System pressure	Max. 1.0 MPa (10 bar)	Enclosure class	IP44 (non-condensing)
Minimum inlet pressure	0.05 MPa (0.50 bar) at 95 °C liquid temperature	Motor protection	No external protection needed
Liquid temperature	+2 °C to +110 °C (TF110)	Approval and marking	VDE, CE

UPM3S FLEX AS 15-60 130 (N), 25-60 130 (N), 25-60 180 (N), 32-60 180 (N) (GFNJD)

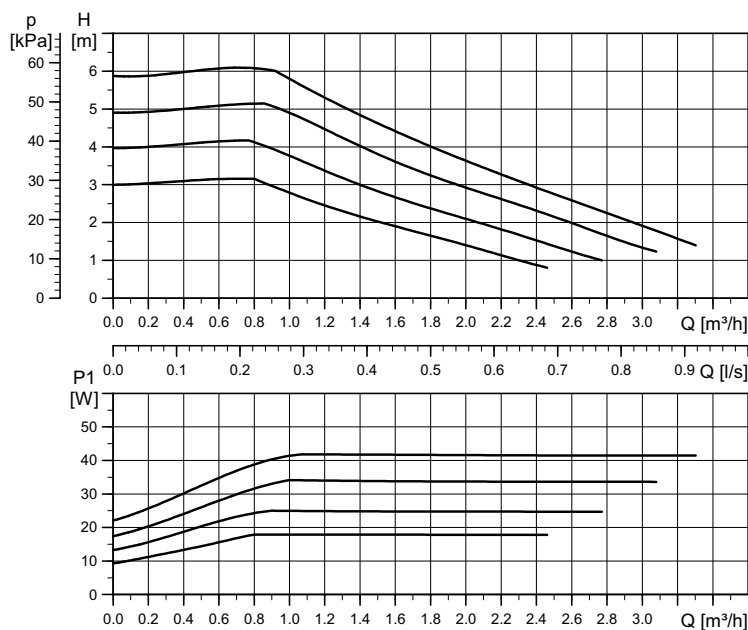

High efficiency

Setting	Max. head _{nom}
Curve 1	3 m
Curve 2	4 m
Curve 3	5 m
Curve 4	6 m

Setting	Max. P ₁ nom
Curve 1	18 W
Curve 2	25 W
Curve 3	34 W
Curve 4	42 W

EEl ≤ 0.20 Part 3
P_{L,avg} ≤ 20 W

TM06 8625 1017

Performance curve

Electrical data, 1 x 230 V, 50 Hz		
Speed	P ₁ [W]	I _{1/1} [A]
Min.	2	0.04
Max.	42	0.40

Settings				
PWM A	PWM C	PP	CP	CC
4	-	-	-	-

Note: For PWM speed curves see data sheet UPM3S 15-60 130 (N), 25-60 130 (N), 25-60 180 (N), 32-60 180 (N) (GFNJD).

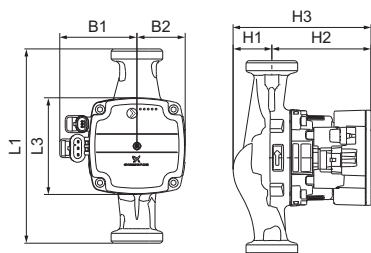

TM06 3879 1115



TM07 1176 1018

Dimensions

Control box position

Pump type	Dimensions [mm]							Connections [inch]	Weight [kg]
	L1	L3	B1	B2	H1	H2	H3		
UPM3S FLEX AS 15-60 130 (N)	130	90	72	45	36	92	128	R 1/2 / G 1	1.8
UPM3S FLEX AS 25-60 130 (N)	130	90	72	45	36	92	128	R 1 / G 1 1/2	1.9
UPM3S FLEX AS 25-60 180 (N)	180	90	72	45	36	92	128	R 1 / G 1 1/2	2.0
UPM3S FLEX AS 32-60 180 (N)	180	90	72	45	36	92	128	R 1 1/4 / G 2	2.2

Technical data

System pressure	Max. 1.0 MPa (10 bar)	Enclosure class	IP44 (non-condensing)
Minimum inlet pressure	0.05 MPa (0.50 bar) at 95 °C liquid temperature	Motor protection	No external protection needed
Liquid temperature	+2 °C to +110 °C (TF110)	Approval and marking	VDE, CE

UPM3L 15-75 130 (N), 25-75 130 (N), 25-75 180 (N), 32-75 180 (N) (GFNJG)

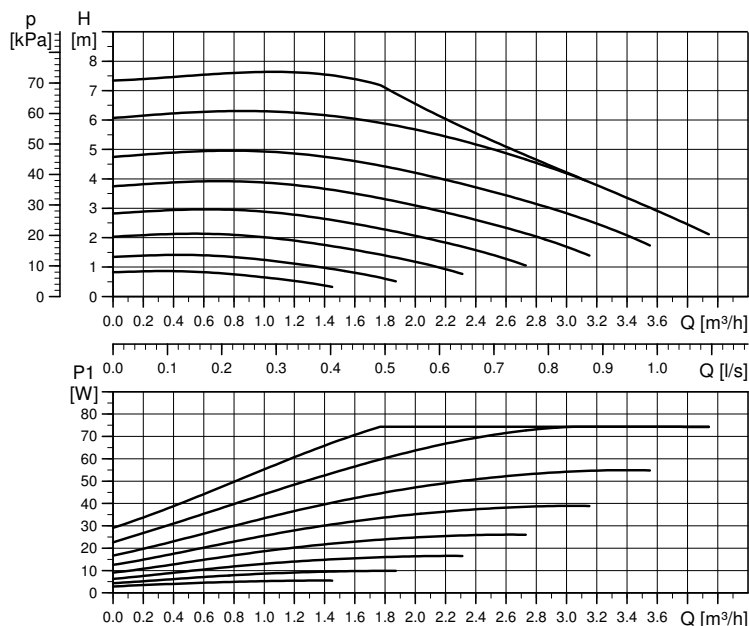

High efficiency

 $EEI \leq 0.20$ Part 3
 $P_{L,avg} \leq 32$ W

TM06 8615 0917

Performance curve

Electrical data, 1 x 230 V, 50 Hz		
Speed	P_1 [W]	$I_{1/1}$ [A]
Min.	2	0.04
Max.	75	0.65

Settings
1 factory preset

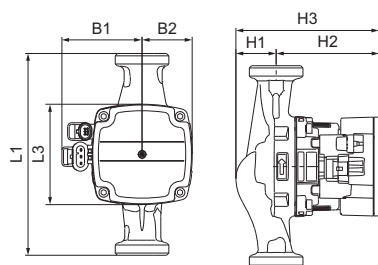

TM06 3878 1115

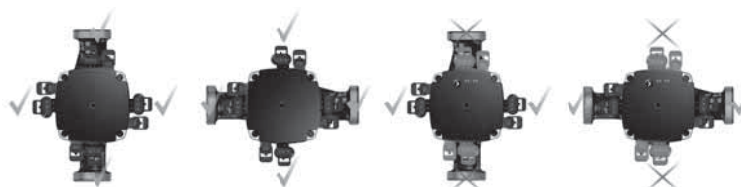

IP44

IPX4D
or K version

TM06 3880 1115

Dimensions

Control box position

Pump type	Dimensions [mm]							Connections [inch]	Weight [kg]
	L1	L3	B1	B2	H1	H2	H3		
UPM3L 15-75 130 (N)	130	90	72	45	36	92	128	R 1/2 / G 1	1.8
UPM3L 25-75 130 (N)	130	90	72	45	36	92	128	R 1 / G 1 1/2	1.9
UPM3L 25-75 180 (N)	180	90	72	45	36	92	128	R 1 / G 1 1/2	2.0
UPM3L 32-75 180 (N)	180	90	72	45	36	92	128	R 1 1/4 / G 2	2.2

Technical data

System pressure	Max. 1.0 MPa (10 bar)	Enclosure class	IP44 (non-condensing) K: IPX4D (condensing)
Minimum inlet pressure	0.05 MPa (0.50 bar) at 95 °C liquid temperature	Motor protection	No external protection needed
Liquid temperature	+2 °C to +95 °C (TF95)	Approval and marking	VDE, CE

UPM3L FLEX AS 15-75 130 (N), 25-75 130 (N), 25-75 180 (N), 32-75 180 (N) (GFNJG)

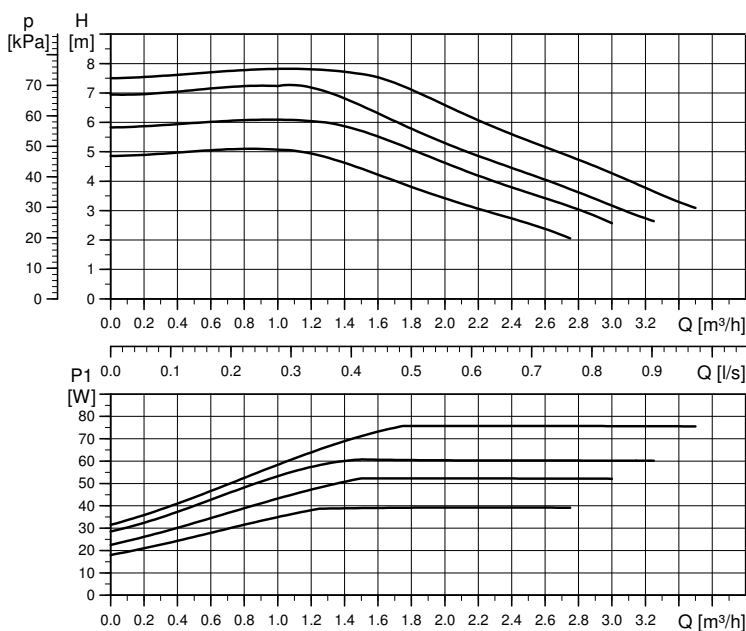

High efficiency

Setting	Max. head _{nom}
Curve 1	5 m
Curve 2	6 m
Curve 3	7 m
Curve 4	7.5 m

Setting	Max. P _{1 nom}
Curve 1	39 W
Curve 2	52 W
Curve 3	60 W
Curve 4	75 W

EEl ≤ 0.20 Part 3
P_{L,avg} ≤ 32 W

TM07 0138 4317

Performance curve

Electrical data, 1 x 230 V, 50 Hz		
Speed	P ₁ [W]	I _{1/1} [A]
Min.	2	0.04
Max.	75	0.65

Settings				
PWM A	PWM C	PP	CP	CC
4	-	-	-	-

Note: For PWM speed curves see data sheet UPM3L 15-75 130 (N), 25-75 130 (N), 25-75 180 (N), 32-75 180 (N) (GFNJG).

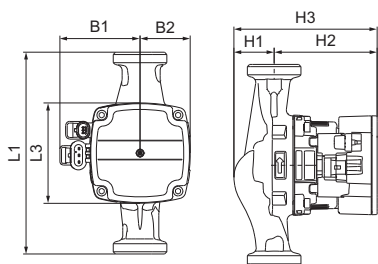

TM06 3878 1115

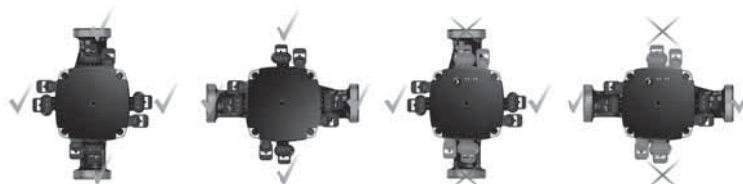

TM06 3880 1115

Dimensions

Control box position

Pump type	Dimensions [mm]							Connections [inch]	Weight [kg]
	L1	L3	B1	B2	H1	H2	H3		
UPM3L FLEX AS 15-75 130 (N)	130	90	72	45	36	92	128	R 1/2 / G 1	1.8
UPM3L FLEX AS 25-75 130 (N)	130	90	72	45	36	92	128	R 1 / G 1 1/2	1.9
UPM3L FLEX AS 25-75 180 (N)	180	90	72	45	36	92	128	R 1 / G 1 1/2	2.0
UPM3L FLEX AS 32-75 180 (N)	180	90	72	45	36	92	128	R 1 1/4 / G 2	2.2

Technical data

System pressure	Max. 1.0 MPa (10 bar)	Enclosure class	IP44 (non-condensing) K: IPX4D (condensing)
Minimum inlet pressure	0.05 MPa (0.50 bar) at 95 °C liquid temperature	Motor protection	No external protection needed
Liquid temperature	+2 °C to +95 °C (TF95)	Approval and marking	VDE, CE

UPMO 15-60 130, UPMO 25-60 130, UPMO 25-60 180, UPMO 60 PH (GFNJB)

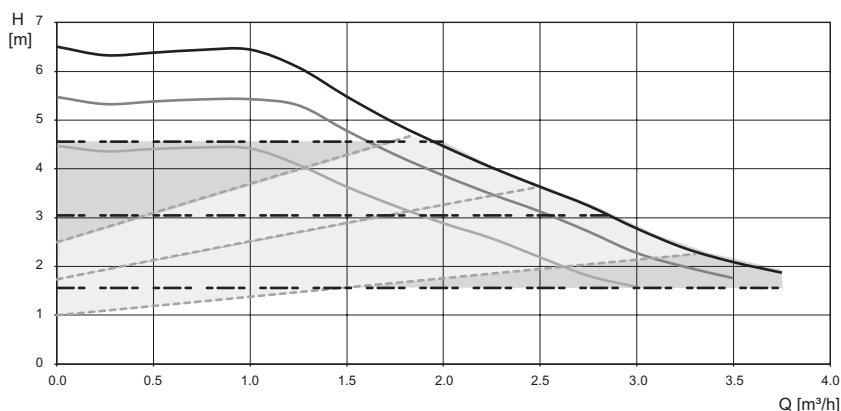

High efficiency

Setting	Max. head _{nom}
CC 1	4 m
CC 2	5 m
CC 3	6 m
CP AA (UFH)	3 m
PP AA (radiator)	3.6 m

Setting	Max. P ₁ nom
CC 1	39 W
CC 2	52 W
CC 3	60 W
CP AA (UFH)	60 W
PP AA (radiator)	60 W

EEI ≤ 0.20 Part 3
P_{L,avg} ≤ 25 W

TM07 1377 1518

Performance curve

Line type	Description
—————	Constant Curve
-----	Proportional Pressure
- - - - -	Constant Pressure

Electrical data, 1 x 230 V, 50 Hz

Speed	P ₁ [W]	I _{1/1} [A]
Min.	4	0.06
Max.	60	0.58

Settings

CC	CP	PP
3	AA	AA

Note: For PWM speed curves contact Grundfos HVAC OEM.

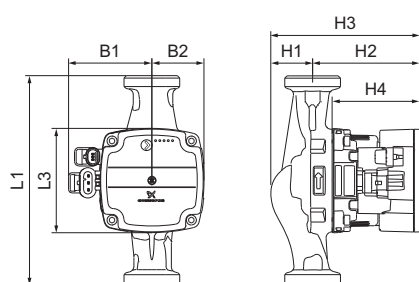

TM07 0820 0618

Dimensions

Control box position

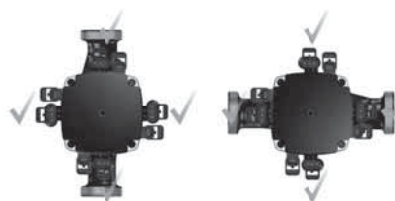

TM07 1176 1018







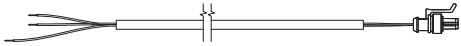
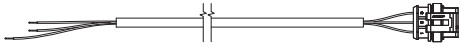
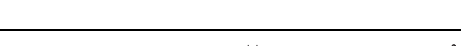
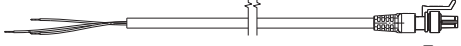
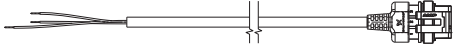
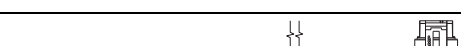

Pump type	Dimensions [mm]								Connections [inch]	Weight [kg]
	L1	L3	B1	B2	H1	H2	H3	H4		
UPMO 15-60 130	130	90	72	47	25.5	102	127.5	-	R 1/2 / G 1	1.8
UPMO 25-60 130	130	90	72	47	25.5	102	127.5	-	R 1 / G 1/2	1.9
UPMO 25-60 180	180	90	72	47	25.5	102	127.5	-	R 1 / G 1/2	2.0
UPMO 60 PH	-	90	72	47	-	102	-	75.5	-	0.97

Technical data

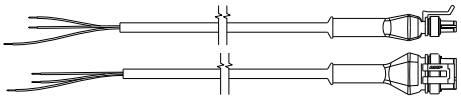
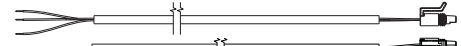
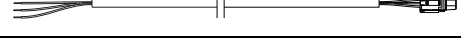
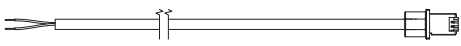
System pressure	Max. 1.0 MPa (10 bar)	Enclosure class	IP44 (non-condensing)
Minimum inlet pressure	0.05 MPa (0.50 bar) at 95 °C liquid temperature	Motor protection	No external protection needed
Liquid temperature	+2 °C to +110 °C (TF110)	Approval and marking	VDE, CE

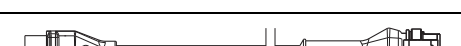
15. Accessories

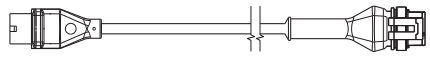
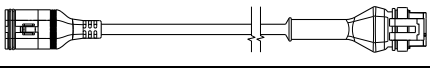
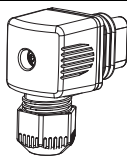
Different accessories, such as cables, gaskets, insulation shells, quick guides or specific mounting parts are available for UPM3. They can be delivered together with the pump, or separately.

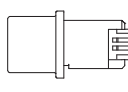
Picture	Product description	Length [mm]	Product number	Pcs/box	Product number box
Power supply Superseal					
	Power supply cable Superseal	1000	98460260	200	59200566
	Power supply cable Superseal	2000	98373382	100	59200567
	Power supply cable Superseal	4000	98460271	50	59200568
Power supply Superseal, overmoulded					
	Power supply Superseal overmoulded	1000	98460258	200	59200569
	Power supply Superseal overmoulded	2000	98373384	100	59200570
	Power supply Superseal overmoulded	4000	98460259	50	59200571
Power supply Superseal, overmoulded, angled					
	Power supply Superseal, overmoulded, angled 90°	1000	98616020	200	59200572
	Power supply Superseal, overmoulded, angled 90°	2000	98616051	100	59200535
	Power supply Superseal, with rubber cap	1000	98664474	200	98677544
Signal cable Mini Superseal					
	Signal cable, Mini Superseal	1000	98460256	200	59200573
	Signal cable, Mini Superseal	2000	98347385	100	59200574
Signal cable FCI					
	Signal cable, FCI, 3 wire, with return signal	1000	96645398	100	59200576
	Signal cable, FCI, 3 wire, with return signal	2000	97940991	100	59200578
	Signal cable, FCI, 2 wire, without return signal	1000	98386202	200	59200575
	Signal cable, FCI, 2 wire, without return signal	2000	97698929	200	59200577
Power cable adapters					
	Superseal Molex cable adapter, overmoulded, with rubber cap	150	98614629	100	59200661
	Superseal Volex cable adapter, overmoulded, with rubber cap	150	98614444	100	59200633
	Superseal installation plug	-	99436122	100	99171101
Signal blind plugs					
	Blind plug, FCI	-	97823485	100	59200643
	Blind plug, Mini Superseal	-	98451691	100	59200639
	Blind plug, Mini Superseal	-	98451691	500	59200640

Gaskets

Gasket material	Pump connection	External diameter (D) [mm]	Internal diameter (d) [mm]	Thickness (s) [mm]	Product number
EPDM	G 1	29.5	21	2	504023
EPDM	G 1 1/2	44	32	2	520046
K for drinking water	G 1 1/2	44	32	2	520226
EPDM	G 2	56	40	2	530243
K for drinking water	G 2	56	40	2	530086

Insulation kits

Insulation kits for warm water applications are available on request. Insulation kits for warm water applications contain two insulation shells. The thickness of the insulation shells corresponds to the nominal diameter of the pump. The insulation kit is tailor-made for the individual pump type and encloses the entire pump housing. Both insulation shells are easy to fit around the pump.

Description	Product number
Insulation shells for UPM3 (1 kit)	98803317
Insulation shells for UPM3 (50 kits)	59200662

Diffusion-tight insulation shells for cold water applications are not available.

Quick guides

Quick guides for different UPM3 variants are available on request.

Description	Product number
UPM3 (K)	98603954
UPM3 (K) FLEX AS	98603960
UPM3 (K) DHW	98857252
UPM3 (K) SOLAR	98603956
UPM3 (K) AUTO	98651459
UPM3 (K) HYBRID	98603930
UPM3 S	coming soon
UPM3 L	coming soon
UPMO	99423010

Pins, clips, O-rings

Pins, clips, O-rings for the different composite housings are available on request.

16. Approvals and certificates

EC/EU declaration of conformity

We, Grundfos, declare under our sole responsibility that the products marked with **GFNJB, GFNJD (UPM3 variants with user interface)** and **GFNJC, GFNJF (other UPM3 variants)**, to which this declaration relates, are in conformity with these Council directives on the approximation of the laws of the EC/EU member states:

Low Voltage Directive (2014/35/EU)

Standards used:

- EN 60335-1:2012/AC:2014/A11:2014
- EN 60335-2-51:2003/A1:2008/A2:2012
- EN 62233:2008

EMC Directive (2014/30/EU)

Standards used:

- EN 55014-1:2006/A1:2009/A2:2011
- EN 55014-2:2015
- EN 61000-3-2:2014
- EN 61000-3-3:2013

Ecodesign Directive (2009/125/EC)

Commission Regulation (EC) No 641/2009

Commission Regulation (EC) No 622/2012

Standards used:

- EN 16297-1:2012
- EN 16297-2:2012
- EN 16297-3:2012

EEI ≤ 0.23 (see individual data sheet or name plate).

The benchmark for the most efficient pumps is EEI ≤ 0.20.

RoHS Directives: 2011/65/EU and 2015/863/EU

Standard: EN 50581:2012

Warning

This appliance can be used by children aged from 8 years and above and persons with reduced physical, sensory or mental capabilities or lack of experience and knowledge if they have been given supervision or instruction concerning use of the appliance in a safe way and understand the hazards involved. Children shall not play with the appliance. Cleaning and user maintenance shall not be made by children without supervision.

Bjerringbro, 1st of January, 2019

Preben Jakobsen
 Technical Director - HVAC OEM
 GRUNDFOS Holding A/S
 Poul Due Jensens Vej 7
 DK-8850 Bjerringbro, Denmark

Person authorised to compile technical file and empowered to sign the EC declaration of conformity.

VDE certificate

These pumps are certified by VDE.

Product code: GFNJB, GFNJC, GFNJD or GFNJF

VDE certificate No. 40039416

This Marks Approval forms the basis of the CE declaration of conformity and the CE marking by the manufacturer or his agent and proves the conformity with the essential safety requirements of the EC Low Voltage Directive (2014/35/EU) including amendments.

EurAsia conformity (EAC) certification

These pumps are certified by EAC and can be marked on request.

Drinking water approvals

UPM3 pumps for drinking water systems are equipped with approved housings, such as CIL3 PPS or stainless steel N. These pumps or their components in contact with water are approved by:

- ACS (FR): Certificate No. 17 ACC NY 116
- WRAS (UK): Certificate No. 1503048
- KTW (DE): Test reports are available for materials in contact with drinking water
- DVGW W270 (DE): Test reports are available for materials in contact with drinking water
- UBA Metall-Bewertungsgrundlage: All metallic parts in contact with water are stainless steel

Grundfos Product Chemical Compliance declaration concerning the non-use of certain chemical substances

GRUNDFOS Holding A/S and its subsidiaries are aware of their responsibilities and are committed not to use hazardous substances in their products.

Grundfos products manufactured and placed on the market within the European Union (EU) and the European Economic Area (EEA) comply with the following EU chemical legislation:

- REACH Regulation (EC 1907/2006)
 - Candidate List of SVHC
 - REACH Annex XIV - Authorisation List
 - REACH Annex XVII - Restriction List
- REACH Regulation; Candidate List of SVHC, Restriction List and Authorisation List (EC 1907/2006)
- RoHS directives (2011/65/EU and 2015/863/EU)
- Battery directives (2006/66/EC and 493/2012)
- Packaging and Packaging Waste directives (94/62/EC and 2004/12/EC)
- Ozone Depleting Substances directives (EC 1005/2009 and 2037/2000)
- Persistent Organic Pollutants directive (EC 850/2004)
- IMO (International Maritime Organization/Hong Kong Convention)

Today, Grundfos products are not fully covered by the RoHS directives.

The RoHS directives on the restriction of the use of certain hazardous substances in electrical and electronic equipment (EEE) will in 2019 apply to all EEE except for the ones explicitly excluded - see in the position paper from Europump what pumps are considered excluded. Reference is made to the position paper from Europump (<http://europump.net/publications/position-papers>).

Grundfos strives on a voluntary basis to be RoHS-compliant regarding the non-use of certain hazardous substances in Grundfos products.

All suppliers of the raw materials and components to Grundfos Holding A/S and its subsidiaries are under contractual obligation to comply with the European chemical legislation.

To ensure that Grundfos is compliant, we have taken the following initiatives:

- Grundfos has launched the Grundfos Focus List in order to give our suppliers, contractors and other relevant stakeholder worldwide a tool to help comply with chemical legislation. Grundfos has prepared the Grundfos Focus List, which bans or restricts the use of certain chemical substances in Grundfos products, Grundfos production processes and at Grundfos facilities (www.grundfos.com/focus-list)
- Grundfos has implemented an IT-platform to support the work of securing compliance with the Focus List and a better supplier collaboration to secure a high data quality and reliability.
- Grundfos continuously performs audits of their suppliers to ensure compliance with their contractual obligation to comply with the chemical legislation.

- Grundfos does not accept banned or restricted hazardous substances in their products. It is a standard task in product development projects to ensure that banned or restricted hazardous substances are not used.

REACH Regulation (EC 1907/2006)

Information regarding REACH Candidate List of substances of very high concern for Authorisation

At Grundfos, we run our business in a responsible and ever more sustainable way. We are committed to creating products and solutions that help our customers and the surrounding world conserve natural resources and reduce climate impacts.

To give our suppliers, contractors and other relevant stakeholders worldwide a tool to help comply with this, we have devised the Grundfos Focus List, which bans or restricts the use of certain chemical substances in Grundfos products, Grundfos production processes and at Grundfos facilities.

The process set-out in Grundfos is to phase out the use of the substances of very high concern (SVHC) from the REACH Candidate List (www.echa.europa.eu/web/guest/candidate-list-table).

With the recent update of the REACH Candidate List of substances of very high concern for Authorisation as of 27.06.2018 where Lead; CAS No. 7439-92-1 has been added, we are making an exemption from our internal procedures, since a timely phase out is not possible.

Lead is only used in applications that are declared as exemptions in the EU RoHS Directive and the purpose of the RoHS Directive is to eliminate risk of harm:

- Copper alloy containing up to 4 % lead by weight (used in fittings, unions etc.)
- Lead as an alloying element in aluminum containing up to 0.4 % by weight (used in very few parts)
- Lead as an alloying element in steel for machining purposes and in galvanised steel containing up to 0.35 % lead by weight (used in very few parts)
- Lead in high melting temperature type solders (used electronic components)

At Grundfos, we are working closely together with our suppliers, and all our suppliers are contractually obliged to comply with the Grundfos Focus List, which is our Restricted Substance List: www.grundfos.com/focus-list.

Customer information regarding REACH, RoHS and other relevant chemical legislation and Grundfos' Product Chemical Compliance initiatives

GRUNDFOS Holding A/S and its subsidiaries are aware of their responsibilities and are committed not to use hazardous substances in their products.

We have introduced our Restricted Substance List – the Grundfos Focus List – as the backbone in our product chemical compliance work.

All our suppliers are contractually obliged to comply with the Focus List – no matter the placing of the goods.

To improve the compliance work and to improve the quality process linked to this work, we have also implemented a digital platform to not only secure a far better data quality in our work, but also secure a faster response to our customers in this regard.

The digital platform supports our ISO Management System and secures a robust process with a solid quality performance. All our suppliers are also contractually obliged to sign up to the system and provide compliance data within the system.

We comply with the standard EN 50581:2012 and technically document that we comply with the RoHS directives. This standard is also used in regards of all other legislations listed in the Focus List.

Grundfos continuously performs audits of their suppliers to ensure compliance with their contractual obligation to comply with the chemical legislation.

WEEE Directive 2012/19/EU

Statement regarding compliance of HVAC OEM pumps with WEEE Directive 2012/19/EU

GRUNDFOS Holding A/S and its subsidiaries does not mark HVAC OEM pumps with the symbol for marking of electrical and electronic equipment (EEE).

Grundfos HVAC OEM pumps are delivered to OEM customers exclusively as components for integration into heating and cooling units (e.g. boilers) to be used to manufacture the final equipment.

As Grundfos HVAC OEM pumps are designed and placed on the market as a component to be integrated into other EEE, the manufacturer of the full/combined product will be responsible for marking, any weight declaring, and takeback obligations for the full combined EEE under directive 2012/19/EU.

Any WEEE obligations will depend on the OEM customer's use of the component. It is the responsibility of the OEM customer to assess whether the use of the component is within the scope of directive 2012/19/EU and if this equipment may or may not be affected by WEEE regulation and it is the responsibility of the OEM to report these volumes if affected.

17. Abbreviations

Abbreviation	Explanation
°dH	Degree of German water hardness, replaced by the SI unit mmol/l. Conversion: 1 °dH = 0.1783 mmol/l
AC	Alternating current
ACS	Material safety approval required for materials and products in contact with drinking water in France (Attestation de Conformité Sanitaire)
AUTO	Internally self-controlled pump mode
AUTOADAPT	The control curve is automatically adapted to the actual requirements of the respective application.
CSA	Canadian Standards Association
CC	Constant Curve, control mode limited by speed and power
CE	CE marking is a certification mark that indicates conformity with health, safety, and environmental protection standards for products sold within the European Economic Area (EEA).
CED	Cataphoretic coating (electrophoretically deposited paint, EDP); paintwork with high adhesive strength for long-lasting corrosion protection
CP	Constant Pressure, control mode for constant differential pressure
DC	Direct current
DIN	German institute for standardisation (Deutsches Institut für Normung e.V.)
DVGW	German association for gas and water (Deutscher Verein des Gas- und Wasserfaches)
ECM technology	Electronically commutated motor with wet rotor encapsulation and glandless drive for high-efficiency pumps
EEL	Energy Efficiency Index for pumps, defined by EN 16297
EN	European standard adopted by CEN, CENELEC or ETSI
ErP	Directive 2009/125/EC (formerly EuP, Ecodesign Directive 2005/32/EC) establishing a framework for the setting of environmentally-responsible requirements for energy-driven products
ETL	Electrical Testing Laboratory by Intertek Group plc, certification institute for compliance with North American safety standards
H	Delivery head of pumps, related to the differential pressure
IEC	International Electrotechnical Commission for all electrical, electronic and related technologies
IP	International Protection marking (IEC) or Ingress Protection marking, classifies and rates the degree of protection against intrusion, dust, accidental contact and water provided by mechanical casings and electrical enclosures
KIWA	European institution for testing, inspection and certification, setting drinking water rules for the Netherlands
KTW	German quality standard for rubber and plastic components in contact with drinking water (Kunststoffe in Kontakt mit Trinkwasser)
LIN	Serial communications (bus) protocol (Local Interconnect Network reg. ISO 17987-3)(VDMA 24226 defines protocol for pumps)
MOD	Serial communications (bus) protocol for use with programmable logic controllers (PLC) or remote terminal units (RTU)
N	Stainless-steel housing (NIRO)
NTC	Thermistor with negative temperature coefficient, used as inrush current limiter
P L, avg	Weighted average power input of a pump on a reference profile reg. EN 16297
P1	Power consumption (power supply input)
PN	Pressure class in bar (PN10 = suitable up to 10 bar)
PP	Proportional Pressure, control mode for variable differential pressure

Abbreviation	Explanation
PWM	Digital low-voltage control signal with pulse-width modulation for external control (VDMA 24244 defines control signals for wet-runner circulating pumps)
Q	Volume flow in hydronic systems
REACH	Registration, Evaluation, Authorisation and Restriction of Chemicals (EC 1907/2006)
RoHS	Restriction of Hazardous Substances Directive 2002/95/EC (RoHS1) (European directive on the restriction of the use of certain hazardous substances in electrical and electronic equipment)
TF	Temperature classification of circulation pumps reg. EN 60335-2-51
UL	Certification institute for compliance to North American safety standards (Underwriters Laboratories)
UBA	German Environment Agency (Umweltbundesamt), defines mandatory evaluation criteria for materials and substances that come into contact with drinking water
VBAT	Supply voltage of bus signal (Voltage of Battery)
VDC	Analog low-voltage-signal 0-10 V DC input for external control
VDE	German association of electrotechnology, electronics and information technology (Verband der Elektrotechnik, Elektronik und Informationstechnik)
VDI	Association of German engineers (Verein Deutscher Ingenieure)
VDMA	Mechanical engineering industry association in Germany (Verband Deutscher Maschinen- und Anlagenbau)
VOB	German regulation on conditions for the award and conclusion of works contracts (Vergabe- und Vertragsordnung für Bauleistungen)
WEEE	European Community Directive 2012/19/EU on Waste Electrical and Electronic Equipment
WRAS	Water Regulation Advisory Scheme for drinking water treatment devices in the UK and Northern Ireland

98644852 0519

ECM: 1255865